

CONCORD

3.1 MEGAPIXELS

User's Guide



www.concord-camera.com

CONGRATULATIONS

Congratulations on the purchase of your new camera. Your camera has been carefully engineered and manufactured to give you dependable operation. Read this manual before operating the camera to become more familiar with it.

This manual has been written and formatted with depth and detail so that you can easily follow the instructions to maximize the features of your camera.

CAMERA OVERVIEW

Top/Front

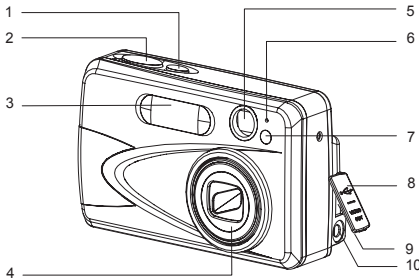

- | | |
|-------------------|-----------------------------------------------------------|
| 1. Power Button | 7. Red-eye Reduction LED/ Self-Timer LED/ AF Assist Light |
| 2. Shutter Button | 8. Port Cover |
| 3. Flash | 9. Mini-USB port |
| 4. Lens/Lens Door | 10. TV-Out port |
| 5. Viewfinder | |
| 6. Flash Sensor | |

- | | |
|--------------------------------------|-----------------------------------------------|
| 11. Flash Ready LED | 23. Wrist Strap Holder |
| 12. Auto-Focus LED | 24. Move to right / Macro () Button |
| 13. Viewfinder | 25. Speaker |
| 14. LCD | 26. Move down / Self-Timer () Button |
| 15. LCD On/Off Button | 27. Memory Card Slot |
| 16. Tripod Socket | 28. Battery Compartment |
| 17. Battery/Memory Card Door | 29. Move to left / Continuous Shot Button () |
| 18. Mode Switch | 30. Reset Button |
| 19. Thumbnail/Wide/ Tele Zoom Button | 31. Delete Button |
| 20. MENU Button | |
| 21. Move up / Flash () Button | |
| 22. OK Button | |

Bottom/Back

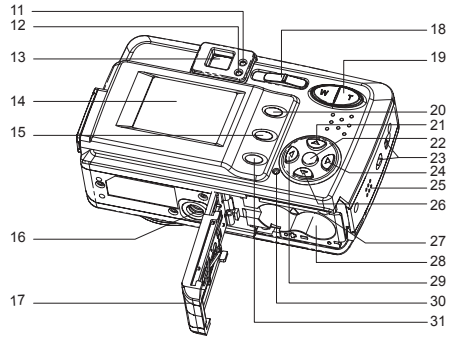

LCD ICONS

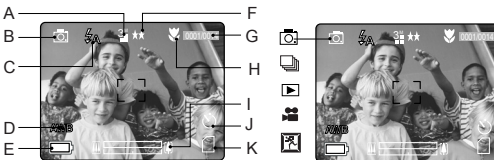

- | | |
|----------------------------|------------------|
| A. Resolution | G. Frame Counter |
| B. Camera Mode | H. Macro |
| C. Flash / Scene Selection | I. Zoom Bar |
| D. White Balance | J. Self-Timer |
| E. Battery Level | K. Memory Card |
| F. Image Quality | |

- | | |
|--|-------------------|
| | : Single Shot |
| | : Continuous Shot |
| | : Review |
| | : Video Clips |
| | : Sport |

Camera Features

- 3.1 Megapixels, 2048 x 1536 Resolution
- 1.5" Color LCD
- 3x Optical Zoom
- 4x Digital Zoom
- AVI Video at 20fps at 320x240 or 160x120 Resolution
- 7 Preset Scenes, 2 Picture Effects
- Macro Mode
- Continuous Shooting Mode
- Self-timer
- Multi-Area Auto-Focus or Center Spot Auto-Focus
- 6MB Internal Memory, SD Card Slot
- Compatible with Windows® 98/98SE/2000/ME/XP and Mac OS 9.0 or higher

TABLE OF CONTENTS

CAMERA OVERVIEW	2
Top/Front	2
Bottom/Back	2
LCD Icons	2
Camera Features	2
GETTING STARTED	5
Attaching the Wrist Strap	5
Loading the Batteries	5
Turning the Camera On and Off	5
Removing the Protective Plastic Film	5
Setting the Language, Date and Time	6
Checking the Battery Level	7
Turning the LCD On and Off	7
Internal Memory / Inserting the Memory Card	8
Setting the camera's operational mode	9
TAKING A PICTURE	9
Taking Pictures with the Viewfinder	9
Taking Pictures with the LCD	10
Using the Auto Focus Lock	11
Setting the Flash	12
Using the Optical Zoom	13
Using the Digital Zoom	13
Taking Pictures in Macro Mode	14
Taking Pictures in Continuous Mode	14
Taking Pictures in Self-Timer Mode	15
Using the Main Menu in Camera Mode	16
• Setting Capture Mode	17
• Taking Pictures in Sport Mode	17
• Setting Image Quality	18
• Setting Image Resolution	18
• Selecting Scene Modes	20
• Setting White Balance	21
• Selecting Photo Effect	21
• Setting EV Compensation	22
• Setting ISO Sensitivity	23
• Setting Metering Method	24
• Setting AF Mode	24
TAKING VIDEO CLIPS	25
Taking Video Clips	25
Taking Video Clips in Self-timer Mode	26
Using the Main Menu in Video Clip Mode	26
Setting Video Resolution	27
REVIEWING YOUR FILES	28
Using Review Mode	28
Reviewing Pictures/Video Clips	28

Enlarging Stored Picture	29
Using Thumbnail View	30
Using the Delete Button	30
Using the Main Menu in Review Mode	32
• Deleting Files	33
• Using Slide Show	34
• Transferring Files from Internal Memory to SD Card	36
• Rotating Files	36
CUSTOMIZING THE CAMERA SETTINGS	37
Setup Menu and Features	39
Setting the Auto Off Time	39
Setting the Language	40
Setting the Date and Time	40
Setting the LCD Brightness	40
Formatting Memory Card	41
Turning Beep On or Off	42
Setting Quick View Interval	42
Setting AF Assist Light	43
RESTORE THE CAMERA TO FACTORY DEFAULT SETTINGS	44
SOFTWARE INSTALLATION GUIDE	45
Computer System Requirements	45
Installation Requirements	45
Using the Installer Splash Screen	46
Flow Diagram for Software Installation	47
Identifying your Operating System	48
Installing the Driver and DirectX 9 - Windows 98/98SE	49
Installing DirectX 9 - Windows 2000	51
Installing ArcSoft PhotoImpression - all Windows users	52
Installing Adobe Acrobat Reader 5 - all Windows users (optional)	54
CONNECTING THE CAMERA TO THE COMPUTER	56
Downloading Pictures and Video Clips onto your Computer	56
Using ArcSoft PhotoImpression	57
Unplugging your Camera from the Computer	58
TV MODE	59
Connecting the Camera to the Television	59
Using the TV as a Live Viewfinder	59
Reviewing Pictures and Video Clips on your TV	59
ERROR MESSAGES	60
TROUBLESHOOTING	61
GETTING HELP	65
CAMERA SPECIFICATIONS	68
SAFETY TIPS AND MAINTENANCE	71
REGULATORY INFORMATION	74

GETTING STARTED

ATTACHING THE WRIST STRAP

Be sure to use the wrist strap to avoid dropping the camera accidentally. When carrying the camera by the strap, don't let it dangle to avoid shocks/damage to the exterior and/or interior of the camera.

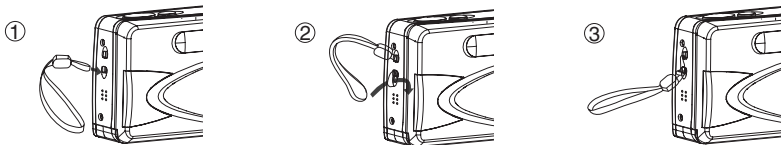

LOADING THE BATTERIES

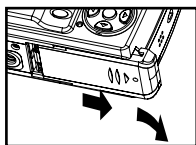

fig.1.1

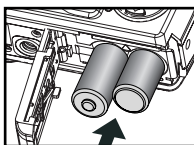

fig.1.2

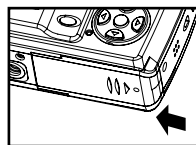

fig.1.3

The camera uses 2x AA alkaline, lithium or rechargeable batteries. Rechargeable Batteries (NiMH) are highly recommended.

1. Slide the Battery/Memory Card door in the direction of the arrow, and lift it open. (fig.1.1)
2. Insert the batteries according to the polarity indication shown on the edge of the battery compartment (fig.1.2)
3. Shut the Battery/Memory Card door by sliding it in the direction of the arrow, and close it securely. (fig.1.3)

TURNING THE CAMERA ON AND OFF

The Power Button is located at the top of the camera.

1. Press and hold the Power Button (Ⓜ) for more than 1 second to turn the camera on.
 - The Concord logo will appear on the LCD for about 2 seconds.
 - If the camera is in Camera Mode (📷) or Video Clip Mode (📹), the lens cover will open, and the lens will extend out automatically to the wide-angle position. Do not block the lens during extension.
 - The LCD will turn on automatically and display live view.
2. To turn the camera off, press the Power (Ⓜ) Button.

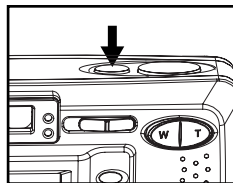

Note: To extend battery life,

- The LCD will turn off after 1 minute of inactivity. After the LCD is automatically turned off, the Flash Ready LED blinks. Press any buttons to reactivate the LCD.
- The camera will automatically power off after 2 minutes of inactivity by default. Press and hold the Power (Ⓜ) Button for more than 1 second to turn the camera back on.

REMOVING THE PROTECTIVE PLASTIC FILM

To prevent the LCD from possible scratches or damages during transportation, the LCD is covered with a clear plastic film. Remember to remove the protective film for a clearer view of the subject when taking pictures.

SETTING THE LANGUAGE, DATE AND TIME

When the camera is powered on for the first time, the Language, Date and Time menus will appear.

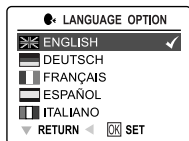

fig. 1.1

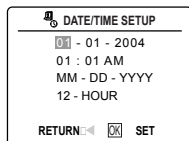

fig. 1.2

1. Press ▲ or ▼ to highlight the desired language. (fig. 1.1)
2. Press the OK button to select. The next screen will show the DATE/TIME SETUP page. (fig. 1.2)
3. Press ► to highlight the Date field, the Time field, the Date Format field or the Time Format field. The selected segment will blink.
4. Press ▲ or ▼ to change the number in the blinking position, press ► to go to the next field.
5. Press the OK button to exit DATE/TIME setting. The next screen will display live view.

Note:

1. For each language, there is a default setting on Date format and TV broadcast standard. To change the TV broadcast standard, refer to page 59..

Language(s)	Date Format Setting	TV Broadcast Standards
English / Español / 日本語	MM/DD/YYYY	NTSC
Francis / Deutsch /Italiano/ Nederlands/Português	DD/MM/YYYY	PAL
中文	YYYY/MM/DD	PAL

2. If the batteries are removed or flat for about 4 minutes, the time setting will resume to factory settings. When the camera is powered on again, the DATE/TIME setup screen will appear on the LCD. To reset date/time, follow steps 2-5 above; to skip the date/time setting, press the OK button. You can set the date/time at a later time. For instructions, refer to p.40.

CHECKING THE BATTERY POWER LEVEL

The battery power level indicator represents the level of power of the batteries. The meaning of each icon is as follows:

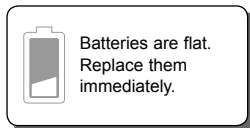
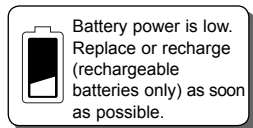
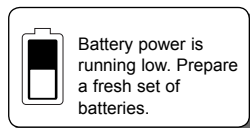
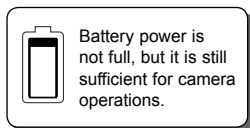
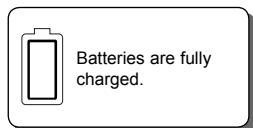

Note:

- The camera's battery level indicator may not accurately reflect the actual power condition of the rechargeable batteries, even if they have been fully recharged. This is an inherent problem with rechargeable batteries, which is not related to the performance of the camera. For better performance, Ni-MH rechargeable batteries are recommended.
- Be sure to remove the batteries if the camera will not be used for an extended period of time to prevent corrosion or battery leakage.

TURNING THE LCD/ICONS ON OR OFF

The camera is featured with a 1.5" LCD that is highly convenient for framing subjects during image/video capture, reviewing stored images/video clips, and for on-screen display of the camera's current settings.

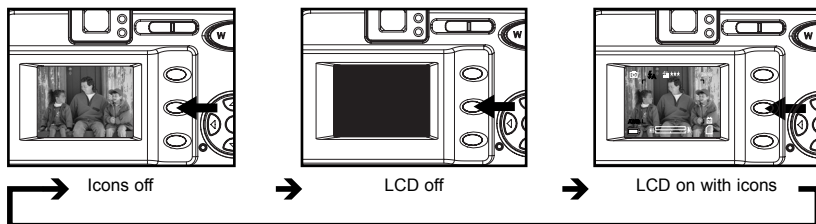

Press the () button repeatedly to toggle between the different LCD modes.

Note:

- To save battery power, it is recommended to turn off the LCD display.
- After one minute of inactivity, the LCD will automatically power off. When the LCD is auto-powered off, the flash LED blinks. Press any button to resume the LCD.
- In () Review Mode, only the LCD icons can be turned on or off.

INTERNAL MEMORY/INSERTING THE MEMORY CARD

Internal Memory

The camera is equipped with 6MB of internal memory that can be used for storage as soon as you start taking pictures or recording video clips.

Status	Memory in Use
Memory card is not inserted.	Internal Memory
Memory card is inserted.	Memory Card

NOTE!: The files stored in the internal memory will remain there until the Transferring Files option is selected. Refer to the Transferring Files section on page 35.

Inserting the Memory Card

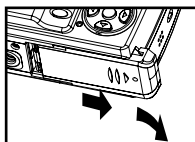

fig.1.1

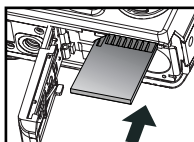

fig.1.2

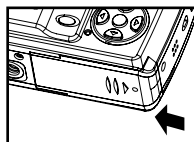

fig.1.3

In addition to the 6MB internal memory, the camera can use a Secure Digital (SD) memory card to store images and/or video clips.

1. Slide the Battery/Memory Card door in the direction of the arrow and lift it open. (fig. 1.1)
2. Insert the memory card in the direction as shown in fig.1.2, then gently, but firmly push the SD card into the slot as far as possible. NEVER forcefully push the card into the camera to avoid damaging both the card and/or the camera. When the card is fully engaged, a click can be heard.
3. Close the Battery/Memory Card door properly and securely. (fig. 1.3)

After inserting the SD card, power on the camera, and the SD card will be checked for its compatibility with the camera. If it is compatible, the camera will immediately accept it for storage. Otherwise, the camera will prompt you to format the card before usage. To format the SD card, refer to p. 41.

Removing the Memory Card

1. Gently push the edge of the memory card with your fingertip to eject it.
2. Carefully pull out the card.

If the SD card is locked when the camera is powered on, the Shutter Button will be disabled. In this case, power off the camera first, take out the SD card, gently slide the switch to unlock it, then reload the SD card into the camera.

Note:

- Do not touch the metal contact plate of the SD card.
- The camera can support SD cards with storage capability of up to 512 MB.

SETTING THE CAMERA'S OPERATIONAL MODES

The camera has 3 operational modes: Camera Mode, Review Mode and Video Clip Mode.

To change the camera operational mode, slide the mode switch horizontally to the corresponding position.

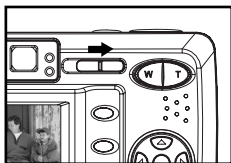

Camera Mode

For taking pictures or customizing your camera settings for picture taking.

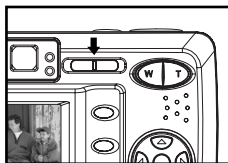

Review Mode

For browsing images and video clips, deleting images and video clips, playing a slide show, transferring images and/or video clips from the internal memory to the SD card, or rotating images.

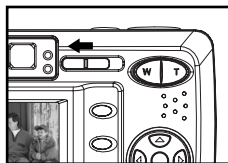

Video Mode

For recording video clips or customizing camera settings for video-clip recording.

TAKING PICTURES

LIVE VIEW THROUGH THE VIEWFINDER



fig.1.1

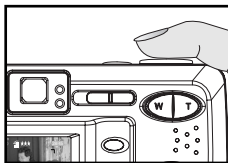

fig.1.2

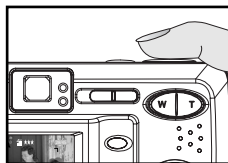

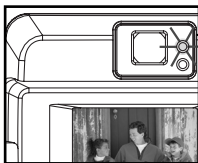

fig.1.3

1. Turn the camera on.
2. Set it to () Camera Mode.
(To save battery power, press the () button to turn off the LCD display).
3. Aim the camera at the subject, then look through the Viewfinder to frame the desired object(s) to be included in the photo. (fig.1.1)
Note: For better results, stand at least 2 ft (0.6m) away from the subject.
4. Press and hold the Shutter button halfway down to activate the Auto-Focus function until the green AF LED stops blinking and the AF frame on the LCD changes to green. (fig.1.2)
(The camera will automatically determine the best focus, and a rapid click can be heard.)
5. Hold the camera steady with both hands, then firmly press the Shutter button down fully to capture the image. (fig.1.3)
 - When the image is captured, a beep can be heard.
 - After an image has been captured, the Flash Ready LED next to the Viewfinder will blink to indicate that the image is being stored.

Flash Ready LED



Lit
The camera is recording a video clip.

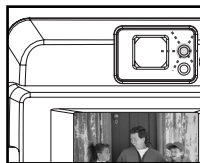

Blinking
The flash is recharging, or LCD is in standby mode.

Note: When the camera is capturing or storing a picture or video clip, do not power the camera off; otherwise, the picture or video clip may become corrupted.

LIVE VIEW THROUGH THE LCD



fig. 1.1

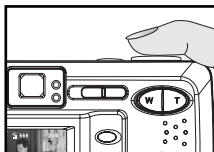

fig. 1.2

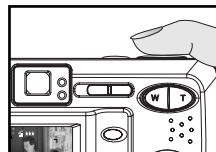





fig. 1.3

1. Turn the camera on.
2. Set it to () Camera Mode.
(If the LCD display is turned off, press the () button repeatedly until the LCD display is on).
3. Aim the camera at the subject, then look at the LCD to frame the desired object(s) to be included in the photo. (fig.1.1)
Note: For better results, stand at least 2 ft (0.6m) away from the subject in Normal Mode.
4. Press the Shutter button halfway down to activate the Auto-Focus function until the green AF LED stops blinking and the AF frame on the LCD changes to green. (fig.1.2)
(The camera will automatically determine the best focus, and a rapid click can be heard.)
Note:
 - For more information on Focus Lock, refer to p. 11.
 - To change AF mode, refer to p. 24.
5. Hold the camera steady with both hands, then press and hold the Shutter button down fully to capture the image. (fig.1.3)
 - When the image is captured, a beep can be heard.
 - After an image has been captured, the Flash Ready LED next to the Viewfinder will blink to indicate that the image is being stored.
 - A preview of the image will be displayed on the LCD for a second. To change the preview time, refer to p. 42.
 - The picture counter number displayed in the LCD will be updated.
6. If you are not satisfied with the captured image, simply press () button to delete it before it is saved. For more information, refer to p. 30.

USING AUTO-FOCUS LOCK

When the subject is not located at the center of the picture, use this feature to lock the focus on the subject before using the usual procedures to take a picture.

Auto-Focus LED

When the **Shutter** button is pressed halfway, the Auto-Focus feature will be activated and the Auto Focus (green) LED will display the status of the Auto-Focus lock.

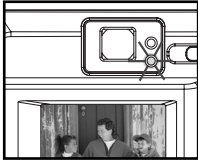

Lit
The subject is in focus.

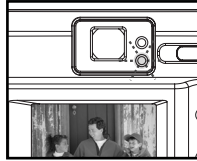

Blinking
The camera is adjusting the focus.

Auto-Focus Frame



Auto-Focus Frame

AF Frame Color	Description
White	Not in focus.
Green	The subject(s) is in focus.

Using the focus lock:



fig. 1.1

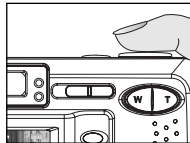

fig. 1.2



fig. 1.3

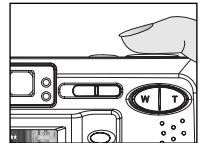

fig. 1.4

1. Aim the camera so that the AF frame at the center of the LCD screen is positioned on the "off-centered" subject . (fig.1.1)
2. Hold the camera steady with both hands, then press and hold the Shutter button halfway down until the AF frame changes to green and the green AF LED stops blinking. (fig.1.2)
3. Recompose your picture. (fig.1.3)
(Be sure to press and hold the Shutter button down halfway while recomposing the picture.)
4. To capture the picture, press the Shutter button down fully. (fig.1.4)

Note: The AF LED will continue to blink in the following conditions:

1. There are several subjects at different distances within the focus lock area. Recompose the picture by moving the camera slightly.
2. There is no color contrast. Recompose the picture with a subject that contains more color.
3. There is insufficient lighting. Increase the lighting in the surrounding area.

SETTING THE FLASH



fig. 1.1

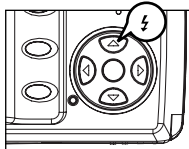

fig. 1.2



fig. 1.3

To set the flash:

Press \blacktriangle / ⚡ repeatedly until the desired indicator appears on the LCD.

Flash Mode	Description
⚡A Auto Flash (Default)	The camera judges if a flash is required. If the environment is too dark, the flash will fire.
⚡A ⦿ Auto + Red-Eye	Use this mode to reduce the occurrence of "red-eyes" when taking pictures with a flash. The camera will automatically detect when the flash is needed and the flash will fire after a short delay.
⚡ Flash ON	Flash will fire in any lighting condition. The "red-eye" reduction function also included in this mode.
⦿ Flash OFF	In this mode, the flash will not fire, regardless of the lighting condition. Use this mode to capture the mood of ambient lighting. This mode is also useful for places that prohibit flash photography, such as museums, aquarium, archeological exhibitions, etc. <ul style="list-style-type: none"> To prevent blurry pictures in dim-lighting environment, hold the camera steady when pressing the Shutter button or mount the camera on a tripod.

Note:

- The flash needs to recharge after it is fired. If the Shutter button is pressed when the flash is charging, the Flash Ready LED will blink. Wait for a short while, then press the Shutter button again to take a picture.
- Some of the scene selection will deactivate the flash setting. For more information, refer to p. 20.

USING THE OPTICAL ZOOM

The camera provides up to 3x optical zoom to take pictures.

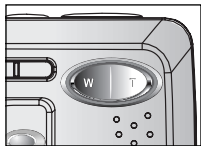

fig. 1.1



fig. 1.2



fig. 1.3

1. Press **T** (Tele) to zoom in to your subject.

The optical zoom status is displayed in white in the zoom bar on the LCD ().

2. Press **W** (Wide) to zoom out.

USING THE DIGITAL ZOOM

The camera also provides 4x Digital Zoom. Combined with the 3x Optical Zoom, it can provide up to 12x magnification of your pictures.



fig. 1.1



fig. 1.2

How to use digital zoom:

1. Turn the LCD on.
2. Press **T** until the white optical zoom bar reached the mid-marker ().
3. Continue to press **T** to activate the digital zoom. The digital zoom status is shown in blue in the zoom bar on the LCD ().
 - Allow for a short delay before the digital zoom can be activated.
4. Press **W** to zoom out.

Activating/Deactivating Digital Zoom

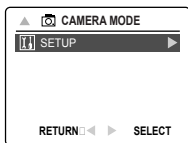

fig. 1.1

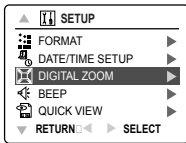

fig. 1.2

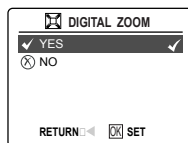

fig. 1.3

1. In Camera Mode, press **MENU** to display the Main Menu.
2. Press **▼** repeatedly until **SETUP** is highlighted, then press **▶** to enter its submenu.
3. Press **▼** repeatedly until **Digital Zoom** is highlighted, then press **▶** to enter its submenu.
4. Press **▲** or **▼** to highlight Yes or No.
 - By default, it is set to On.
5. Press **OK** to select.

Important:

1. Hold your camera steady when using Digital Zoom to prevent blurred photos, caused by jittery movement. It is recommended to either place your camera on a steady surface or mount it on a tripod.
2. The image quality may degrade slightly with Digital Zoom.
3. Digital Zoom can only be monitored with the LCD and not through the optical viewfinder.

TAKING PICTURES IN MACRO MODE (CLOSE-UP SHOTS)

This mode enables the camera to capture pictures in close distances.

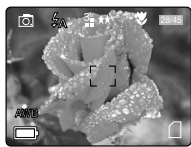
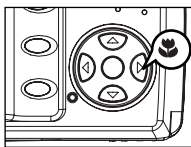

1. Press the **▶** button. The Macro icon () will be displayed on the LCD.
2. Frame the subject in the LCD.
 - The best shooting range is between 15 cm to 60 cm. (5.9 in. – 23.6 in.)
3. Press and hold the **Shutter** button halfway to activate the Auto-Focus function until the green AF LED stops blinking and the AF frame changes to green.
4. Press the **shutter** button fully to take the picture.



Note:

1. When Macro Mode is selected, the camera will turn on the LCD if it is automatically turned off.
2. Zoom buttons do not work in Macro Mode.

TAKING CONTINUOUS SHOTS

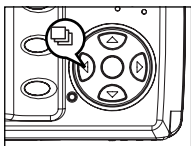
This feature enables the camera to continuously capture 7 consecutive pictures with VGA (640x480) resolution when the Shutter button is pressed and held.





1. Press the **◀** button. The Continuous Shot icon () will be displayed on the LCD.
2. Frame the subject in the LCD screen, press and hold the **Shutter** button halfway to activate the Auto-Focus function until the green AF LED stops blinking and the AF frame changes to green.
3. Press and hold the **Shutter** button down fully to capture the pictures.
 - The camera will automatically and continuously capture 7 consecutive images at approximately 3 images per second in 640 x 480 resolution.
4. To exit the Continuous Shot function, press the **◀** button until  disappears from the LCD.

Note:

- In Continuous Shooting Mode the flash is disabled, as the recharging time will slow it down.
- The camera will only capture pictures in 640 x 480 resolution in Continuous Shooting Mode.
- The LCD will be blank when the images are taken in the Continuous Shooting Mode.

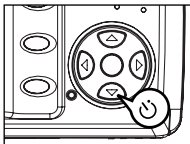
TAKING PICTURES WITH SELF-TIMER



1. In () Camera Mode, press ▼ button, the Self-Timer icon () will appear on the LCD.
2. Place the camera on a flat surface or tripod.
3. Use the LCD to compose the picture, then press the **Shutter** button to activate the Self-Timer. The Self -Timer LED will blink slowly for 7 seconds, faster for the remaining 3 seconds, then the image will be captured.

Note:

- The Self-Timer is automatically deactivated once the image is taken.
- To deactivate the Self-Timer before taking a picture, press ▼ button until the Self-Timer icon () disappears from the LCD.

Photography Hints -

Since the Self-Timer LED indicator at the front of the camera flashes, the photographer will have time to join in the photograph and know when the camera has completed taking a picture when the Self-Timer LED light stops blinking.

USING THE MAIN MENU IN CAMERA MODE

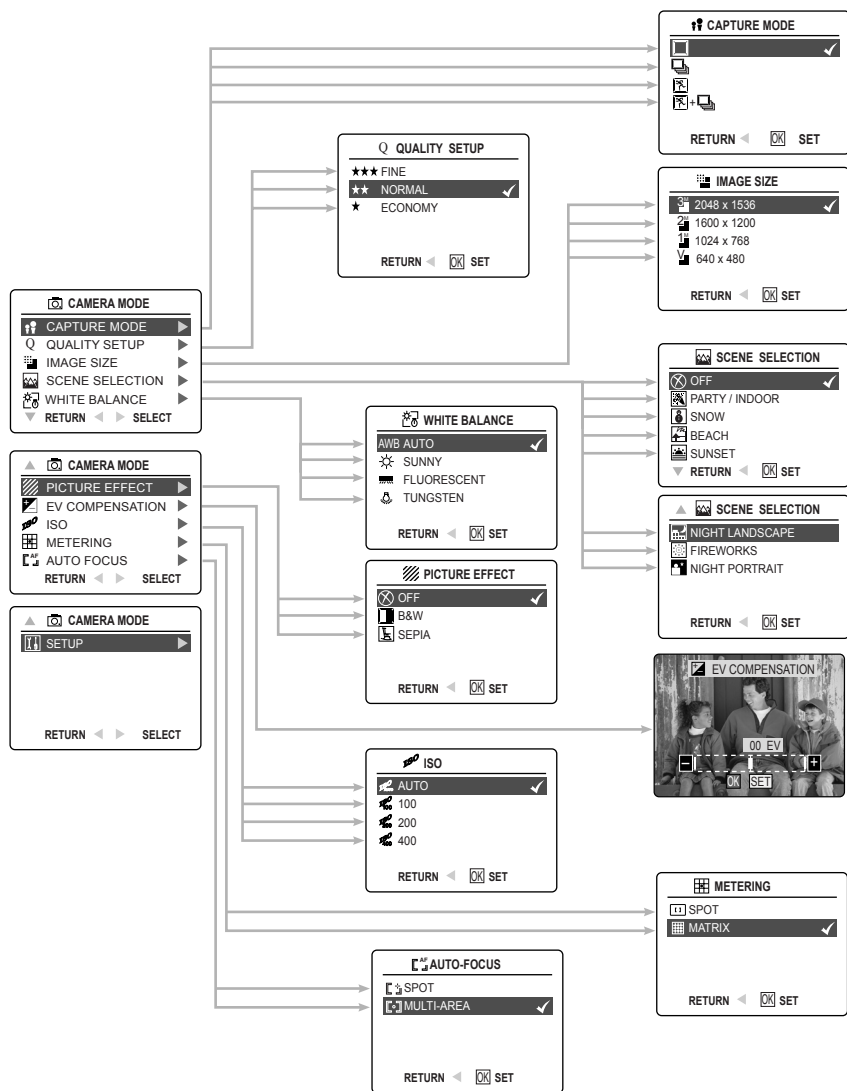





USING THE MAIN MENU IN CAMERA MODE

Follow the steps below to set the advanced shooting options in the camera through the Main Menu.

1. Turn the camera on.
2. Set the camera to () Camera Mode.
3. Press the **MENU** button to display the Main Menu.
4. Press **▲** or **▼** repeatedly until the desired option is highlighted.
5. Press **▶** to enter the submenu.
6. Press **▲** or **▼** repeatedly in the submenu to toggle between the options.
7. Press the **OK** button to make a selection.
 - All selections will be marked by a red check mark.
8. To return to the previous menu, press **◀**.
9. To exit the menu at any time, press the **MENU** button.

SETTING CAPTURE MODE

The capture mode menu has 4 features to choose for taking pictures.

Capture Mode Option	Description
() Single	The camera will take 1 picture at a time.
() Continuous Shooting	The camera will continuously take 7 consecutive pictures (at 640 x 480 resolution) when the Shutter button is fully pressed. The flash is disabled in this mode.
() Sport	The camera will take 1 picture at a time in Sport Mode.
( + ) Continuous Shooting with Sport	The camera will continuously take 7 consecutive pictures in Sport Mode



Note: Flash will be deactivated in Continuous Shooting Mode.

TAKING PICTURES IN SPORT MODE

This mode is used for taking pictures of sports and other high-speed activities. The camera will automatically choose a higher shutter speed and wider aperture to capture fast-moving action to avoid blurriness.

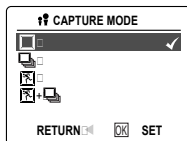
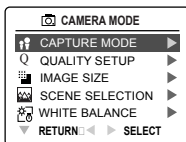
Setting Sport Mode:



1. In the main menu, press **▶** to enter the Capture Mode submenu.
2. Press **▲** or **▼** to highlight Sport () or Sport + Continuous Shooting ().
3. Press **OK** to enter the mode.

Taking a picture in Sport Mode:

1. Frame the subject in the LCD.
2. Press and hold the **Shutter** button halfway to activate the focus until the green AF LED stops blinking and the AF frame changes to green.
3. Press the **Shutter** button down fully to take the picture.

Note: Hold your camera steady to prevent blurriness. It is recommended to either place your camera on a flat, steady surface or mount it on a tripod.

SETTING IMAGE QUALITY

The Image Quality setting determines the amount of compression used to reduce the size of the stored image file in order to economize space in the memory.

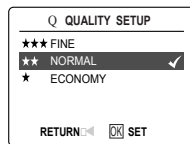
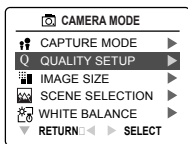

Quality	JPEG Compression Ratio	Description
Fine	4.5:1	Fine image quality can be used for making prints.
Normal (Default)	11:1	Normal image quality can be used for general purpose pictures.
Economy	17:1	Economy image quality can be used for pictures that will be sent via e-mail.

To change the image quality:

1. When (Q) QUALITY SETUP is highlighted, press ► to enter the (Q) Quality Setup submenu.
2. Press ▲ or ▼ repeatedly until the desired setting is highlighted.
3. Press the **OK** button to select the Quality Mode.
4. Press the **MENU** button to return to picture taking mode.

Note: The default Quality is set at NORMAL.

SETTING IMAGE RESOLUTION

Image Resolution determines the size of a captured image. Higher resolution images contain more details and have larger file sizes.

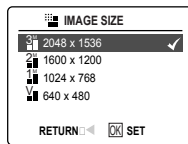
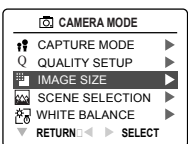

Images Stored on 6MB memory (approx.):

Resolution Quality	3MP (2048 x 1536)	2MP (1600 x 1200)	1.3MP (1024 x 768)	VGA (640 x 480)
Fine (4.5:1)	4	6	14	36
Normal (11:1)	8	13	32	79
Economy (17:1)	15	23	55	130

Images Stored on 16MB memory (approx.):

Resolution Quality	3MP (2048 x 1536)	2MP (1600 x 1200)	1.3MP (1024 x 768)	VGA (640 x 480)
Fine	9	14	33	82
Normal	19	31	74	181
Economy	34	53	125	297

Images Stored on 32MB memory (approx.):

Resolution Quality	3MP (2048 x 1536)	2MP (1600 x 1200)	1.3MP (1024 x 768)	VGA (640 x 480)
Fine	20	29	68	171
Normal	41	65	154	376
Economy	71	111	261	616

Images Stored on 64MB memory (approx.):

Resolution Quality	3MP (2048 x 1536)	2MP (1600 x 1200)	1.3MP (1024 x 768)	VGA (640 x 480)
Fine	42	60	140	351
Normal	84	135	316	771
Economy	146	229	536	1270

Images Stored on 128MB memory (approx.):

Resolution Quality	3MP (2048 x 1536)	2MP (1600 x 1200)	1.3MP (1024 x 768)	VGA (640 x 480)
Fine	83	119	279	698
Normal	167	268	628	1532
Economy	290	455	1064	2512

How to change the resolution:





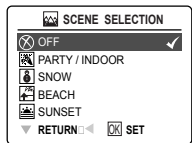
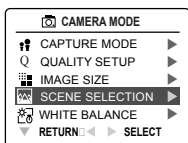

1. When Resolution is highlighted in the Main Menu, press ► to enter the () Resolution submenu.
2. Press ▲ or ▼ repeatedly until the desired setting is highlighted.
3. Press the OK button to select the mode
4. Press the MENU button to return to the picture-taking mode.

Note: The default image resolution is 3MP.

SELECTING SCENE MODES

The preset scene modes are helpful to quickly optimize the various settings to get the best capture of specific scenes.



Preset Scene	Description
Off (default)	No Scene Selection.
 Party/Indoor	Use this mode to capture the details of candlelit scenes or other indoor background lighting conditions.
 Snow	Use this mode to capture snow scenes, and prevent the image from losing color.
 Beach	Use this mode to capture the details in shining water scenes.
 Sunset	This mode captures the deep hues and color variations in sunsets and sunrises.
 Night Landscape	A slow shutter speed is used to capture the lights in night scenes. Photography Tip: With the slower shutter speed, there is a possibility of causing blurry images, due to camera movement. To reduce the degree of blurriness, you may: <ol style="list-style-type: none"> 1. Set your camera to Night Landscape mode. 2. Place your camera on a tripod or sturdy surface area. 3. Set the camera to Self-Timer mode. 4. Press the shutter button.
 Fireworks	Use this mode to capture the burst of light from fireworks with a slower shutter speed.
 Night Portrait	Use this mode to capture a subject illuminated with the lights in a night scene with a slow shutter speed. <ul style="list-style-type: none"> • Due to the slow shutter speed, mount the camera onto a tripod for better picture quality.

To set the scene selection:

1. When Scenes Select is highlighted, press ► to enter its submenu.
2. In the Scene menu, press ▲ or ▼ to choose between the options.
3. Press the **OK** button to select the Scene Mode.
4. Press the **MENU** button to return to picture taking mode.

Note: Change of the flash setting will deactivate the scene setting selected in Scene Selection

SETTING WHITE BALANCE

By default the camera uses Auto White Balance to reproduce colors under different lighting conditions. For mixed lighting conditions, it is recommended to use the Auto White Balance option.

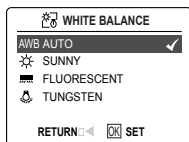
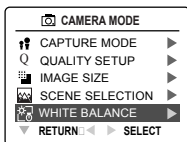

White Balance Mode	Description
Auto	The camera will automatically choose the white balance setting. Use this setting in variable conditions.
Sunny	For outdoors with sufficient sunlight.
Fluorescent	For indoors with fluorescent or ambient lighting conditions.
Tungsten	For indoors with tungsten lighting conditions.

To change the White Balance:

1. When White Balance is highlighted, press **▶** to enter its submenu.
2. Press **▲** or **▼** repeatedly until the desired setting is highlighted.
3. Press the **OK** button to select the White Balance mode.
4. Press the **MENU** button to return to picture-taking mode.

SELECTING THE PICTURE EFFECT

You can shoot with different picture effects.

Picture Effect	Description
OFF (Default)	Taking pictures without effect.
B&W	Taking pictures in black and white.
SEPIA	Taking pictures in sepia tones like old pictures.

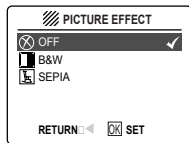
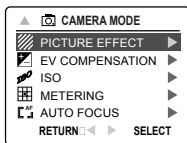

To set photo effect:

1. When Picture Effect is highlighted, press **▶** to enter its submenu.
2. Press **▲** or **▼** repeatedly until the desired setting is highlighted.
3. Press the **OK** button to select the picture effect.
4. Press the **MENU** button to return to the picture-taking mode.

SETTING EXPOSURE COMPENSATION

The camera uses Auto Exposure to give well-exposed pictures under most lighting conditions. If the captured picture of the main subject turns out to be too light or too dark, use the Exposure Compensation feature to improve the exposure aspect.

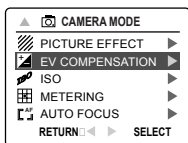





Exposure Compensation Mode	Description
+	Increasing the Exposure in pictures that are too dark, will make the picture lighter.
-	Decreasing the Exposure in pictures that are too light, will make the picture darker.

To change the Exposure Compensation level:

1. Press ▲ or ▼ repeatedly in the Main Menu until () Exposure Compensation is highlighted.
2. Press ► display the Exposure Compensation bar on the LCD.
3. Press ◀ or ▶ to change the Exposure Compensation between - 2.0 to +2.0.
4. Press the OK button to select the desired value.
 - The camera will return to the picture-taking mode automatically after selection.

SETTING THE ISO SENSITIVITY

Raise the ISO speed when you wish to reduce jittery camera movement or to turn the flash off when shooting in dark surroundings.

ISO Setting	Description
 Auto (default)	Equivalent to setting of ISO 100 under normal conditions. When lighting is poor, camera raises sensitivity automatically to compensate.
 100	100 is best for shooting clear, sharp images in daylight.
 200	200 is ideal for shooting in cloudy situations.
 400	400 is best for shooting in dark surroundings, for example, especially at night.

Note: Higher ISO speeds increase image noise. To take clean images, use as low an ISO speed as possible.

TO CHANGE ISO SETTING:

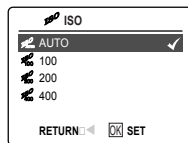
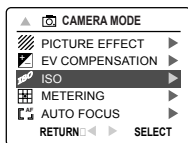

1. When () ISO is highlighted, press ► to enter its submenu.
2. Press ▲ or ▼ repeatedly until the desired setting is highlighted.
3. Press the **OK** button to select the ISO setting.
4. Press the **MENU** button to return to the picture-taking mode.





SETTING LIGHT METERING MODE

You can choose the desired part of the image to use for measuring the brightness and determine the exposure.

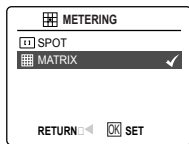
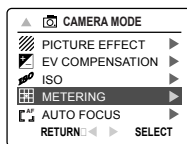
Metering Mode	Description
Spot	Meters the light in the center area of the image. Use this mode when the subject is backlit or surrounded by strong light.
Matrix(default)	Metering the light in different zones. Use this mode when the lighting condition is complex. The camera can adjust the settings to correct exposure for the main subject by metering the position of the subject, the brightness, the direct light, and the backlighting etc.

To change Light Metering mode:



1. When () Metering is highlighted, press  to enter its submenu.
2. Press  or  repeatedly until the desired setting is highlighted.
3. Press the **OK** button to select the Metering Mode.
4. Press the **MENU** button to return to the picture-taking mode.



SETTING AUTO FOCUS (AF) MODE

The camera provides two AF modes to perform the Auto Focus function.

AF Mode	Description
Spot	In this mode, the camera uses the center zone of the subject to perform auto focusing. Use this mode when you want to focus only what you aim at.
Multi-Area (default)	In this mode, the camera automatically determines which area (center, upper-left, upper-right, lower-left, lower-right) is best to perform the auto focusing function. Use this mode when the lighting condition is complex.

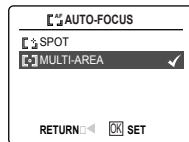
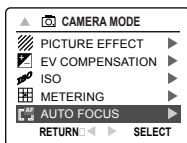
To set AF mode:



1. When AF mode is highlighted, press  to enter its submenu.
2. Press  or  repeatedly until the desired setting is highlighted.
3. Press the **OK** button to select the AF Mode.
4. Press the **MENU** button to return to picture taking mode.

TAKING VIDEO CLIPS

TAKING VIDEO CLIPS

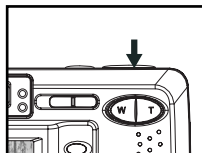
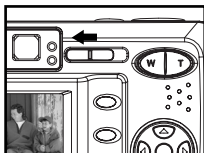
**To record a video clip:**

- Slide the Mode Switch to () Video Clip Mode.
 - The time limit is showed on the upper-right corner of the screen.
- Position the subject in the LCD.
- Press the **Shutter** button down fully to start recording a video clip. The time recorded will be shown on LCD. The camera records a video clip until the memory is full.

To stop recording:

- Press the **Shutter** button again to stop recording.
- OR
- The camera will stop recording only after the memory is full.

Video Clip Information



Resolution: QVGA (320x240) or
 QQVGA (160x120) (Best for e-mail)
 Frame rate: 20fps
 File Format: AVI (Motion Picture)

**Note:**

- Do not open the battery door or turn the camera off when recording. Otherwise, the video clip may not be stored.
- Higher capacity memory cards can record video clips for a longer duration.
- The Flash, Macro, and Continuous Shooting are deactivated in Video Mode.

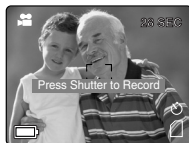
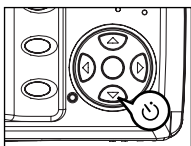





RECORDING A VIDEO CLIP WITH THE SELF-TIMER

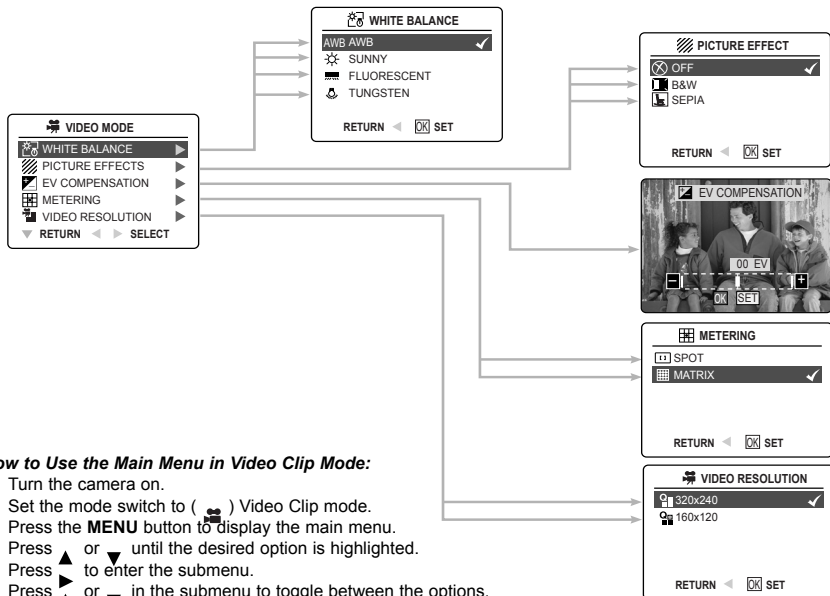

1. In the () Video Clip Mode, press  button, and the Self-Timer icon () will appear on the LCD.
2. Place the camera on a flat surface or mount it on a tripod.
3. Use the LCD to compose the picture, then press the **Shutter** button to activate the Self-Timer.
The Self -Timer LED will blink slowly for 7 seconds, faster for the remaining 3 seconds then starts recording.
4. Press the Shutter button again to stop recording. Otherwise, the camera will continue to record until the memory limit is reached.

USING THE MAIN MENU IN VIDEO CLIP MODE

**How to Use the Main Menu in Video Clip Mode:**

1. Turn the camera on.
2. Set the mode switch to () Video Clip mode.
3. Press the **MENU** button to display the main menu.
4. Press  or  until the desired option is highlighted.
5. Press  to enter the submenu.
6. Press  or  in the submenu to toggle between the options.
7. Press the **OK** button to make a selection.
 - All selections will be marked by a red check mark.
8. To return to the previous menu, press .
9. To exit the menu at any time, press the **MENU** button.

Note:

- To understand the differences between the various White Balance settings, refer to p.21.
- To set the different Picture Effects, refer to p.21.
- For more information about Exposure Compensation, refer to p.22.
- For more information about Metering differences, refer to p.24.

SETTING VIDEO CLIP RESOLUTION

Note: 160x120 resolution is ideal for email.

To change the video resolution:

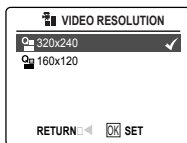
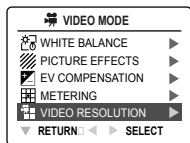

1. When Video Resolution is highlighted in the Main Menu, press **▶** to enter the () Resolution submenu.
2. Press **▲** or **▼** repeatedly until the desired setting is highlighted.
3. Press the **OK** button to select the mode
4. Press the **MENU** button to return to video clip mode.

REVIEWING YOUR FILES

REVIEWING THE PICTURES/VIDEO CLIPS

In (▶) review mode, you can review your stored pictures and video clips through the LCD.

Note: When a memory card is inserted into the camera, only the pictures stored in the memory card will be displayed in the Review Mode. To view the pictures in the internal memory, transfer files from internal memory to the SD card (refer to p.35). Or turn the camera off, remove the memory card, and then turn the camera back on.

To review pictures/video clips:

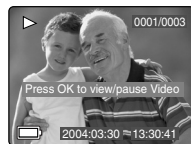
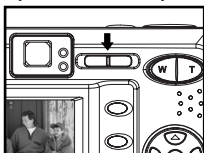

- Slide the Mode Switch towards (▶). The lens will retract in Review Mode.
- Press ◀ or ▶ repeatedly to scroll through each file.
 - The file type and frame counter will be displayed on the LCD.

File Indication	File Type
JPEG	Still Picture
AVI	Video Clip

0001/0003

Number of total pictures /video clips

Number of current picture/video clip

- When a Video Clip Icon (**AVI**) is displayed on the LCD, press the **OK** button to play the video clip.

Note: Press the **OK** button to pause or resume playing video clip.
To stop playing the video clip, press the **Shutter** button.

ENLARGING THE PICTURES

In () Review Mode, you can enlarge your pictures to take a closer look at the subject on the LCD. This feature is for viewing purposes only and will not affect the stored image.

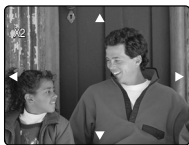







2x Enlargement



4x Enlargement

Resolution	Maximum Enlargement
2048 x 1536	4x
1600 x 1200	4x
1024 x 768	4x
640 x 480	2x

To enlarge:

1. In () Review Mode, press  or  repeatedly to scroll through the stored pictures and video clips.
2. While viewing a stored still picture, press the **T** button for different magnifications.
3. Press , ,  or  to navigate around the picture. When the picture can pan no farther in one direction, the directional arrow will disappear.
4. Press **W** button to zoom out.

Note: Video Clips cannot be magnified.

REVIEWING YOUR FILES IN THUMBNAIL

The thumbnail view can be accessed in (▶) Review Mode by pressing either Menu or Wide button.



fig. 1.1



fig. 1.2

Using the Quick Access Button:

1. In the (▶) Review Mode, press **W** button, nine thumbnail images or video clips will appear on the LCD display in a few seconds. (fig. 1.2) The first file will be shown first.
2. Press ▲, ▼, ◀ or ▶ repeatedly to look through all the pictures and video clips. The selected picture or video clip will be highlighted by a red border.
3. Press the **OK** button to view the picture or video clip in full screen.

Using the review menu:

1. In (▶) Review Mode, press **MENU** to enter Review Menu.
2. Press ▲ or ▼ repeatedly to highlight Thumbnail.
3. Press ▶ button to have nine thumbnail images or video clips appear at once on the LCD display.
4. Press ▲, ▼, ◀ or ▶ repeatedly to look through all the pictures and video clips.
5. Press the **OK** button to view the picture or video clip in full screen. Or press **MENU** button to return to the previous screen.

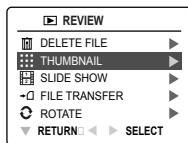

USING THE DELETE BUTTON TO DELETE YOUR FILES

You can delete your files in Quick View, Thumbnail or in Review Mode by using the Delete button.



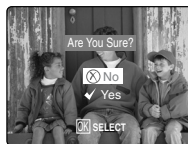
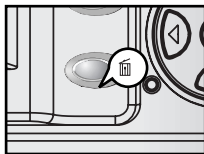

Note: Once a file is deleted, it cannot be recovered.







Deleting in Quick View Mode (Camera Mode)

1. In the (📷) Camera Mode, after a picture is taken, the LCD will show the picture for a second. If you are not satisfied with the picture, press the (🗑️) button, the screen will display the message "Are you sure?"
Note: To change the Quick View time, refer to p.42.
2. Press ▲ or ▼ to highlight No or Yes.
3. Press the **OK** button to confirm selection.
 - If Yes is selected, the picture will be deleted.
 - If No is selected, the picture will be saved.



Deleting in Review Mode**Delete One**

1. In () Review Mode, press  button once, the screen will display the message "Are you sure?"
2. Press  or  to highlight No or Yes.
3. Press the **OK** button to select.
 - If No is selected, no change will be made, and the camera will return to the Review Mode.
 - If Yes is selected, the file will be deleted.

Delete All

1. In () Review Mode, press  button twice, the screen will display the message "Delete All, Are you sure?"
2. Press  or  to highlight No or Yes.
3. Press the **OK** button to select.
 - If No is selected, no change will be made, and the camera will return to the Review Mode.
 - If Yes is selected, all the files will be deleted.

Deleting in Thumbnail Review Mode

1. When thumbnail view is displayed (refer to P.30), select the image you want to delete, then press  button, the LCD shows the image in full screen and asks "Are You Sure?"
2. Press  or  to highlight No or Yes.
3. Press the **OK** button to confirm selection.
 - If No is selected, no change will be made, and the LCD will return to the Thumbnail View Mode.
 - If Yes is selected, the selected file will be deleted.

USING THE REVIEW MENU

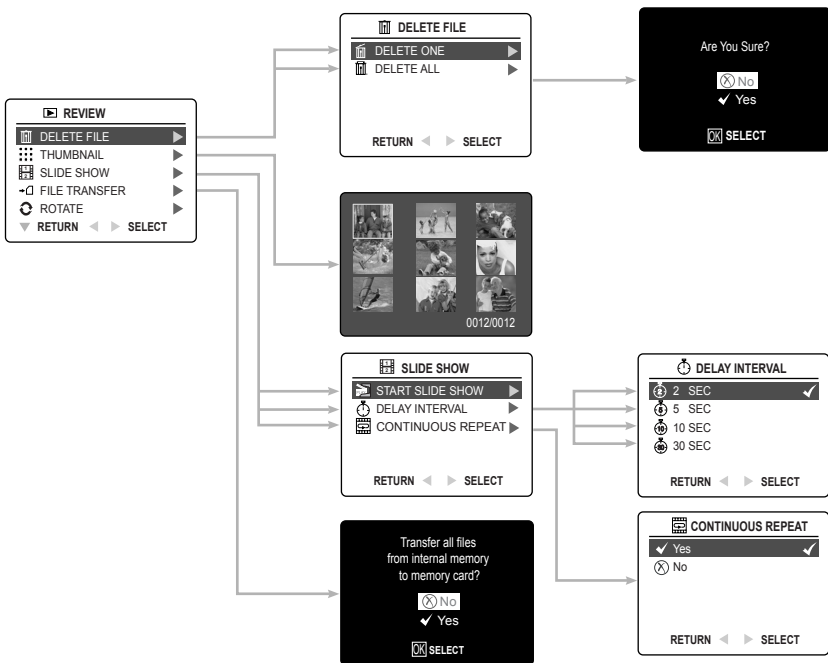
**How to use the Menu in Review mode:**

1. Turn the camera on.
2. Set the Mode Switch to (**▶**) Review Mode.
3. Press the **MENU** button to display the Main Menu.
4. Press **▲** or **▼** repeatedly until the desired option is highlighted.
5. Press **▶** to enter its submenu.
6. Press **▲** or **▼** in the submenu to toggle between the options.
7. Press the **OK** button to make a selection.
 - All selections will be marked by a red check mark.
8. To exit the menu, press **◀**.
9. To exit the menu at any time, press the **MENU** button.

DELETING YOUR FILES

Note: Once the files are deleted, they cannot be recovered.

Deleting One File by Using the Review Menu

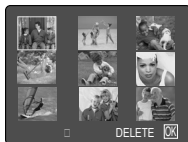
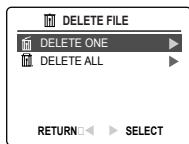

1. In () Review Mode, press the **MENU** button to enter Review Menu.
2. Press **▲** or **▼** to highlight Delete File.
3. Press **▶** to enter its submenu.
4. Press **▲** or **▼** to highlight Delete One, then press **OK**. This LCD shows the images/video clips in thumbnail.
5. Press **◀** or **▶** to highlight the file you want to delete.
6. Press **OK** button. The next screen will read "Are You Sure?"
7. Press **▲** or **▼** to highlight No or Yes.
8. Press the **OK** button to confirm selection.
 - If No is selected, no change will be made, and the camera will return to the Thumbnail View Mode.
 - If Yes is selected, the selected file will be deleted, and the LCD return to the Thumbnail View Mode.

Deleting All Files

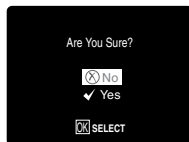
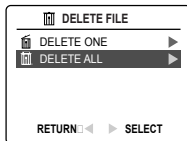

1. In () Review Mode, press **MENU** to enter Review Menu.
2. Press **▲** or **▼** to highlight Delete File.
3. Press **▶** to enter its submenu.
4. Press **▲** or **▼** to highlight Delete All.
5. Press **OK**. The next screen will display the message "Are You Sure?"
6. Press **▲** or **▼** to highlight No or Yes.
7. Press the **OK** button to confirm selection.
 - If No is selected, no change will be made, and the LCD will return to the previous screen.
 - If Yes is selected, all files will be deleted. The LCD will show "No Files!"

RUNNING A SLIDE SHOW

Use the Slide Show feature to automatically display your pictures and videos on the camera LCD screen at a selectable interval rate. You can also run a Slide Show on any video device that is equipped with a video input, such as a television or digital projector.

The Slide Show feature is available when you have at least one picture stored.

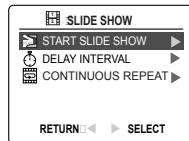
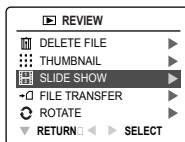

To run a slide show:

1. In () Review Mode, press **MENU** to enter Review Menu.
2. Press **▲** or **▼** repeatedly to select and highlight Slide Show..
3. Press **▶** to enter its submenu.
4. Press **▶** when Start Slide Show is highlighted to begin the Slide Show.
 - Pictures: Each picture will be shown for 2 seconds. To change the display interval, refer to the instructions below.
 - Video clips: Only the first frame of the video clip will be shown.
5. Press **▲** or **▼** once to speed up or slow down the Slide Show.
6. Press **◀** or **▶** to skip to the previous or next image.
7. Press **OK** to pause or resume Slide Show.
8. To quit the Slide Show, press the Menu button.

Note: When an SD memory card is inserted into the camera, only the pictures stored in the memory card will be displayed. To view the pictures in the internal memory, transfer the files onto the SD card or remove the SD card(p.35).

To set the slide show time interval:

The default slide show interval is 2 seconds. You may change the time following the steps below:

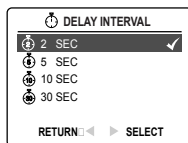
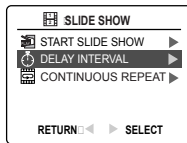
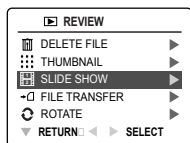

1. In () Review Mode, press **MENU** to enter Review Menu.
2. Press **▲** or **▼** repeatedly to select and highlight Slide Show.
3. Press **▶** to enter its submenu.
4. Press **▲** or **▼** to highlight Delay Interval.
5. Press **▶** to enter the submenu.
6. Press **▲** or **▼** to select the length of time for each picture to be displayed on the LCD: 2, 5, 10 or 30 seconds.
7. Press **OK** to select.
8. Press **◀** to return to the previous menu. Or press **MENU** to exit.

To repeat a slide show

By default, the Slide Show will stop automatically when the last frame is played. However, you can set the camera to play the Slide Show repeatedly by following the steps below:

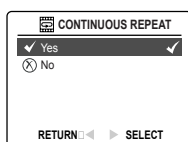
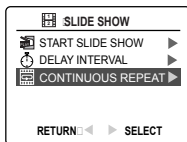
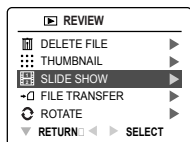

1. In () Review Mode, press **MENU** to enter Review Menu.
2. Press **▲** or **▼** repeatedly to select and highlight Slide Show.
3. Press **▶** to enter its submenu.
4. Press **▲** or **▼** repeatedly to select and highlight Continuous Repeat.
5. Press **▶** to enter the submenu.
6. Press **▲** or **▼** to select Yes or No.
 - If Yes is selected, the camera will play the Slide Show repeatedly after you started playing a Slide Show.
7. Press **OK** to select.
8. Press **◀** to return to the previous menu. Or press **MENU** to exit.

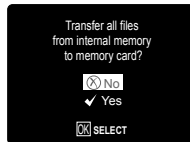
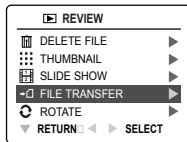

TRANSFERRING FILES FROM INTERNAL MEMORY TO SD CARD

The camera can transfer photos and video clips that are stored in the camera's internal memory to an SD memory card.



1. In () Review Mode, press **MENU** to enter Review Menu.
2. Press **▲** or **▼** repeatedly to select and highlight File Transfer.
3. Press **▶** . The next screen will display the message "Transfer all files from internal memory to memory card"?
4. Press **▲** or **▼** to highlight No or Yes.
5. Press **OK** to confirm selection.
 - If No is selected, no change will be made, and the LCD will return to the previous screen.
 - If Yes is selected, the screen will display "Transferring ..." and all files will be transferred to the SD card.





 TRANSFERRING FILES...
Note:

1. Please insert a memory card that has 6MB or more of available memory. If the SD card does not have sufficient memory to store all the files from the internal memory, the camera will retain the remaining images/video clips in the internal memory and will display the message "Memory Full" as well as the memory card locked icon ().
2. If the SD card is locked, the camera will show memory card locked icon () for about 2 seconds and resume to the Main Menu.
3. If no SD card is inserted in the camera, the LCD shows "No card" for a few seconds, then return to Review menu.

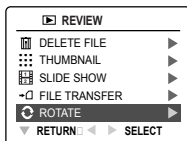
ROTATING THE IMAGES

Stored images can be rotated by 90 degrees clockwise (CW) or counter-clockwise (CCW); the newly-rotated images can then be saved and replace the originally stored images.



1. In () Review Mode, press **▲** or **▼** repeatedly to select the desired image to be rotated.
2. Press **MENU** to enter Review Menu.
3. Press **▲** or **▼** to select and highlight "Rotate".
4. Press **▶** . The selected image will be shown in full size on the LCD display. The rotate icon "  " (to rotate clock wise) and "  " (to rotate counter clock wise) will also appear on the LCD.
5. Press **◀** or **▶** to repeatedly rotate the image 90 degrees clockwise or counter-clockwise.
6. Press **OK** to confirm the selection. The LCD will ask "Save?"
7. Press **▲** or **▼** to highlight "Yes" or "No", and then press **OK** to confirm.
 - If No is selected, no change will be made. The LCD will restore the original image.
 - If Yes is selected, the image will be rotated and saved over the original file. The LCD will show "Saving ..." first, and then show the rotated image.



CUSTOMIZING THE CAMERA SETTINGS

EN

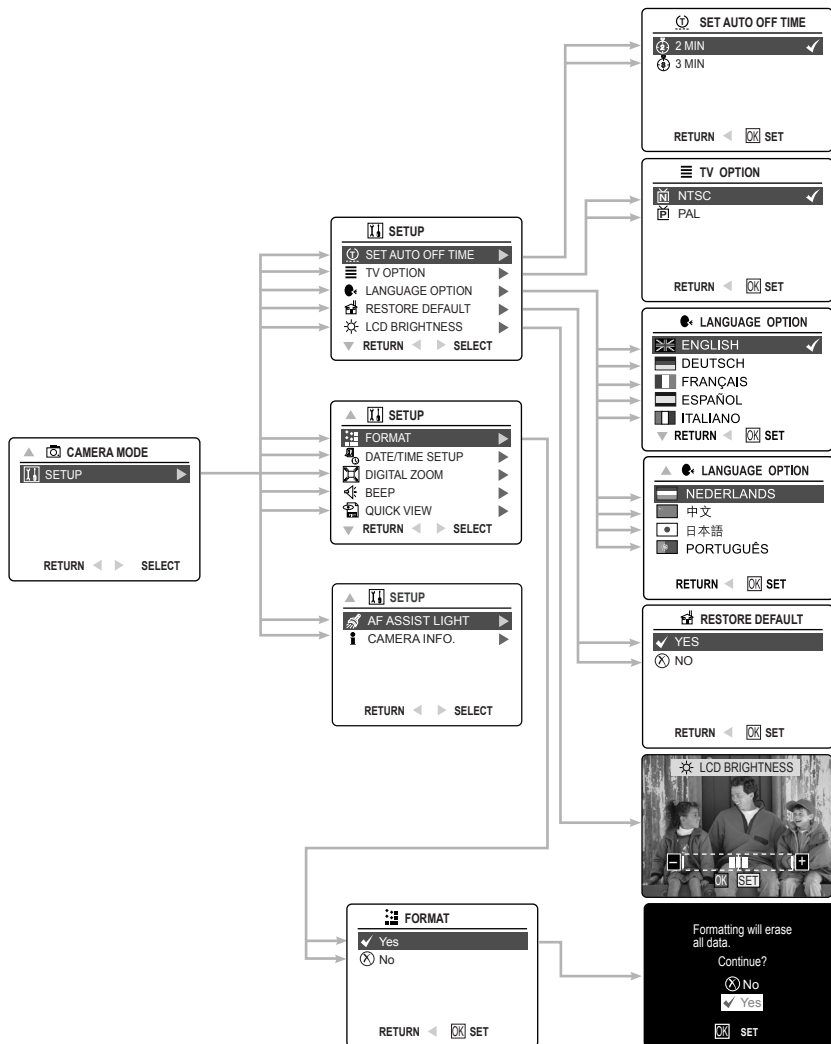

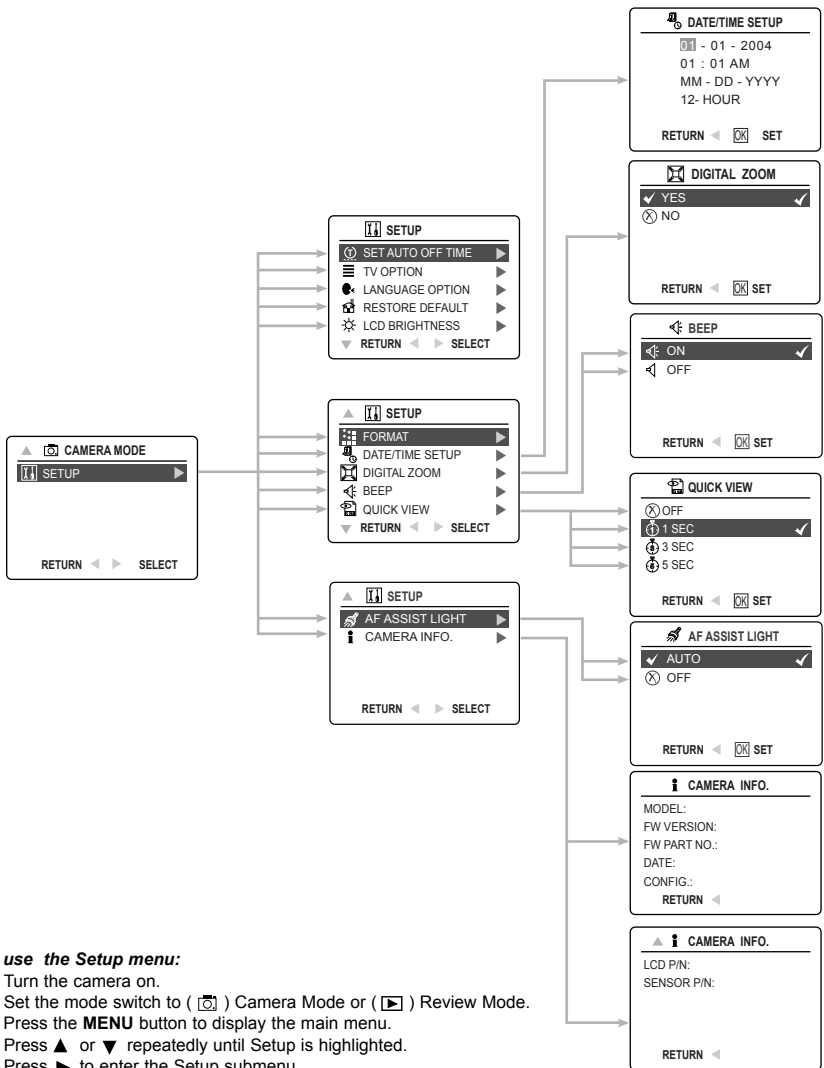

To use the Setup menu:

1. Turn the camera on.
2. Set the mode switch to () Camera Mode or () Review Mode.
3. Press the **MENU** button to display the main menu.
4. Press **▲** or **▼** repeatedly until Setup is highlighted.
5. Press **▶** to enter the Setup submenu.
6. In the Setup menu, press **▲** or **▼** repeatedly to highlight the option you wish to customize.
7. Press **▶** to enter the submenu of the highlighted option.
8. Use the arrow buttons to adjust the setting and press the **OK** button to select.
9. Press **◀** to return to the previous menu **OR** press the **MENU** button to exit.

UN SETUP MENU AND FEATURES

Setup Setting	Options	Description
Set Auto Off Time	2 min, 3 min	Enables the camera to automatically power off when it is idle.
TV Broadcast Standards	NTSC, PAL	Sets the mode that the camera needs to adapt to your TV. (Page 59)
Language Option	English Deutsch Français Español Italiano Nederlands 中文 日本語 Português	Sets the language for display on your camera's LCD. (Page 40)
Restore Default	Yes/No	Restores all camera settings to the factory default. (Page 44)
LCD Brightness		Sets the LCD brightness level. (Page 40)
Format	Yes/No	Formats the memory card, which will delete all files. (Page 41)
Date/Time Setup	Date/Time, Date/Time format	Changes the date/time in your camera and their display format.
Digital Zoom	Yes No	Activates or deactivates the digital zoom.
Beep	On, Off	Activates or deactivates the beep.
Quick View	Off, 1 sec., 3 sec., 5 sec.	Sets Quick View Time interval.
AF Assist Light	Auto, Off	
Camera Info	Model FW Version FW Part No. Date Config. LCD P/N Sensor P/N	Displays the camera version information. This is for information purposes only.

SETTING THE AUTO-OFF TIME

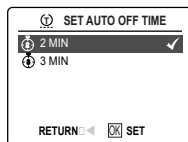
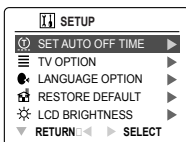
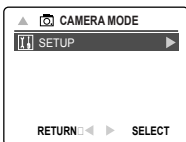

1. In the Setup Menu, press ▲ or ▼ repeatedly until Set Auto Off Time is highlighted.
2. Press ► to enter the submenu.
3. Press ▲ or ▼ to highlight the preferred choice.
4. Press the **OK** button to set.

Notes: The default setting is 2 minutes. Press and hold the Power button for more than 1 second to reactivate the camera after it automatically turns off.

SETTING THE LANGUAGE

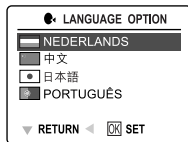
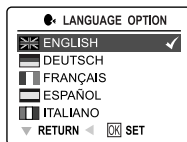
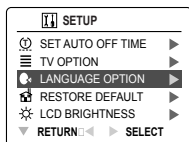

To set the Language:

1. In the Setup menu, press ▲ or ▼ repeatedly until Language option is highlighted.
2. Press ► to enter the Language option submenu.
3. Press ▲ or ▼ repeatedly to highlight the desired language.
4. Press the OK button to set.

SETTING THE DATE AND TIME

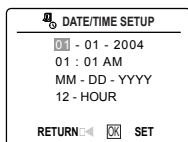
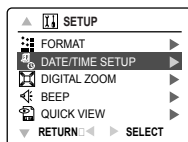

1. In the Setup Menu, press ▲ or ▼ repeatedly until Date/Time Setup is highlighted.
2. Press ► to enter the submenu.
3. Press ► to highlight the Date/Time fields and Date/Time format. The selected segment will blink.
4. Press ▲ or ▼ repeatedly to change the number in the blinking position, press ► to go to the new field.
5. After the Date/Time is set, press the OK button to quit Date/Time setting.

SETTING THE LCD BRIGHTNESS

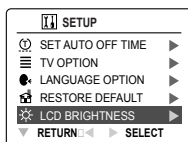
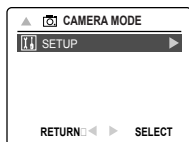

To set the LCD Brightness:

1. In the Setup Menu, press ▲ or ▼ repeatedly until LCD Brightness is highlighted.
2. Press ► to display the LCD Brightness bar on the LCD.
3. Press ◀ or ▶ to adjust the brightness.
4. Press the OK button to set.

FORMATTING THE INTERNAL MEMORY OR MEMORY CARD

CAUTION: !



1. Formatting will delete all pictures and video clips from the memory.
2. During the formatting process, NEVER REMOVE the memory card nor batteries, as it will damage the card and/or the camera.
3. When a memory card is not inserted into the camera, selecting the formatting function will format the internal memory instead. All pictures and video clips stored in the internal memory will be deleted.

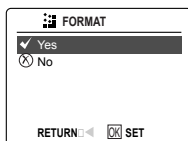
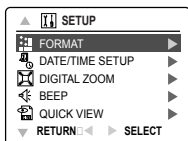

1. In the Setup Menu, press ▲ or ▼ until Format is highlighted.
2. Press ► to enter the Format submenu.
3. Press ▲ or ▼ to highlight No or Yes.
4. Press the **OK** button to set.
 - If No is selected, no change will be made, and the LCD will return to the previous screen.
 - If Yes is selected, the LCD shows "Formatting will erase all data. Continue?" (This will delete all files!)

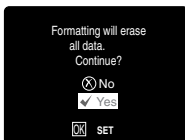

5. Press ▲ or ▼ to highlight No or Yes.
6. Press the **OK** button to set.
 - If No is selected, no change will be made, and the LCD will return to the Setup Menu.
 - If Yes is selected, the LCD will display "Formatting ...", a process that deletes all files.

Note: If "Card Error" is displayed on the LCD screen, it indicates that the memory card is corrupted. Format the memory immediately.

TURNING THE BEEP ON OR OFF

The camera provides an option to enable or disable the beep. By default, the beep is turned ON. The camera beeps in any of the following situations:

- When the camera is powered on.
- After an image is captured. (For this situation, the camera will beep, regardless of the beep setting.)
- When any button is pressed, except the Power Button, the Mode Slide Button and the Zoom Buttons.

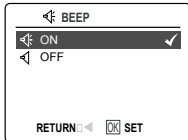
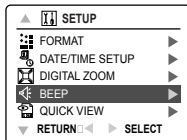

To activate/deactivate the beep:

1. In the Setup Menu, press ▲ or ▼ repeatedly until Beep is highlighted.
2. Press ► to enter its submenu.
3. Press ▲ or ▼ to highlight the desired selection.
4. Press the OK button to set.

SETTING QUICK VIEW TIME INTERVAL

The camera provides programmable Quick View duration, which is the duration of time for an image to be displayed immediately after a picture is taken.

Quick View	Description
Off	No quick view, LCD continues to show live view.
1 sec (Default)	Displays the image for 1 second then resumes to live view.
3 sec	Displays the image for 3 seconds then resumes to live view.
5 sec	Displays the image for 5 seconds then resumes to live view.

How to select Quick View time phrase:

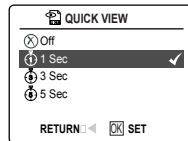
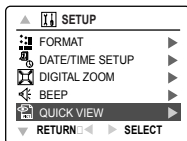

1. In the Setup menu, press ▲ or ▼ until Quick View is highlighted.
2. Press ► to enter its submenu.
3. Press ▲ or ▼ to highlight the desired selection.
4. Press the OK button to set.

SETTING AF ASSIST LIGHT

In low-lighting environment, the camera will turn on the built-in AF (Auto Focus) Assist Light to illuminate the subject that is being focused on.

AF Assist Light	Description
Auto (Default)	The camera will turn on AF assist light if it is needed.
Off	The camera will not turn on the AF assist light even if the subject is in a low-light condition.

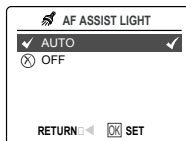
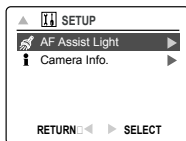
How to change AF assist light setting:

1. In the Setup menu, press ▲ or ▼ until AF Assist Light is highlighted.
2. Press ► to enter its submenu.
3. Press ▲ or ▼ to highlight the desired selection.
4. Press the **OK** button to set.

RESTORING FACTORY DEFAULT SETTINGS

To restore the default settings in your camera:

- In the Setup Menu, press ▲ or ▼ until Restore Default is highlighted.
- Press ▲ or ▼ to highlight **No** or **Yes**, and then press **OK** to confirm.
 - If No is selected, no change is made. The LCD returns to the previous screen.
 - If Yes is selected, the LCD shows "Are you sure?"
- Press ▲ or ▼ to highlight **Yes** or **No**, then press **OK**.
 - If No is selected, no change will be made. The LCD returns Setup page.
 - If Yes is selected, the camera will be reset to the factory default setting. The LCD will show "Restoring..." and then return to setup page. The Default settings will be restored.

The table below lists the default settings:

OPTION	DEFAULT STATUS
Camera Mode	Single Shot
Image Size	2048 x 1536
Quality	Normal
Flash	Auto Flash
White Balance	AWB
LCD Brightness	Center (0)
Scene Selection	OFF
Digital Zoom	Yes
Exposure Compensation	0
ISO	Auto
Metering	Matrix
Photo Effect	None
Time Out	2 Min
Slide show interval	2 Seconds
Beep	On
Quick View	1 Sec
AF Mode	Multi-Area
Continuous Repeat	Off
AF Assist Light	Auto
TV Mode	NTSC for USA/Japan, PAL for Europe/Asia
Date/Time Format	USA/Japan: MM/DD/YYYY, 12-hour Europe/Asia: DD/MM/YYYY, 24-hour

SOFTWARE INSTALLATION GUIDE

The software that comes with your Concord 3 Megapixel Digital Camera includes driver, reader, and photo editing programs. These programs transfer the pictures or video clips from your camera to your computer, and enable you to view them on your computer monitor. Refer to the following list of computer system requirements for installation of the programs.

Computer System Requirements

Windows

- 300MHz Pentium II processor or equivalent.
- Microsoft Windows 98/98SE, Windows Me, Windows 2000 Professional, Windows XP Home / Professional / Media Center
- 360MB free hard disk space .
- 128MB of RAM
- Minimum 800 x 600 display with 16-bit color (1024 x 768 with 24-bit color or better is recommended)
- USB Port
- 4x CD-ROM Drive

Macintosh

- Mac OS 9.0, 9.1, 9.2 and X 10.1 or later
- Power PC-based
- 32MB of RAM
- 640 x 480 display with Thousands of colors (Millions of colors recommended)
- Built-in USB Port

Installation Requirements

The installer will automatically detect which software applications need to be installed or if they are not necessary. Please read the installation requirements before proceeding with the installation process.

System	Windows 98/98SE	Windows Me	Windows 2000	Windows XP	Macintosh
Install Camera Driver	X				
Install DirectX 9	X		X		
Install ArcSoft PhotoImpression	X	X	X	X	
Install Adobe Acrobat Reader 5					
Camera automatically detected by the computer (no driver installation required)		X	X	X	X

USING THE INSTALLER SPLASH SCREEN

The installer will automatically detect which software applications need to be installed or if they are not necessary. This will be indicated by the buttons on the splash screen that appears when the CD-ROM is inserted into the computer:



Color	Description
Yellow (●)	Required or highly recommended to install.
Gray (●)	Already installed or not necessary to install.

Option	Description
Camera Drivers	The USB Mass Storage camera drivers enable the camera to become an external drive on your computer.
Microsoft DirectX 9	DirectX 9 enables the movie playback applications on your computer to playback video clips that are captured with the camera.
ArcSoft PhotoImpression 2000	This photo software enables you to edit and enhance pictures.
Adobe Acrobat Reader 5	Adobe Acrobat Reader enables you to view the electronic version of the User's Guide.
User's Guide	Direct link to our camera support website. Ensure that an internet connection is established before clicking on the link.

FLOW DIAGRAM FOR SOFTWARE INSTALLATION

To transfer the pictures and video clips from the memory, the camera must be connected to a computer with the provided Mini-USB cable. Additional setup may be required by some operating systems before connecting the camera to the computer for the first time.

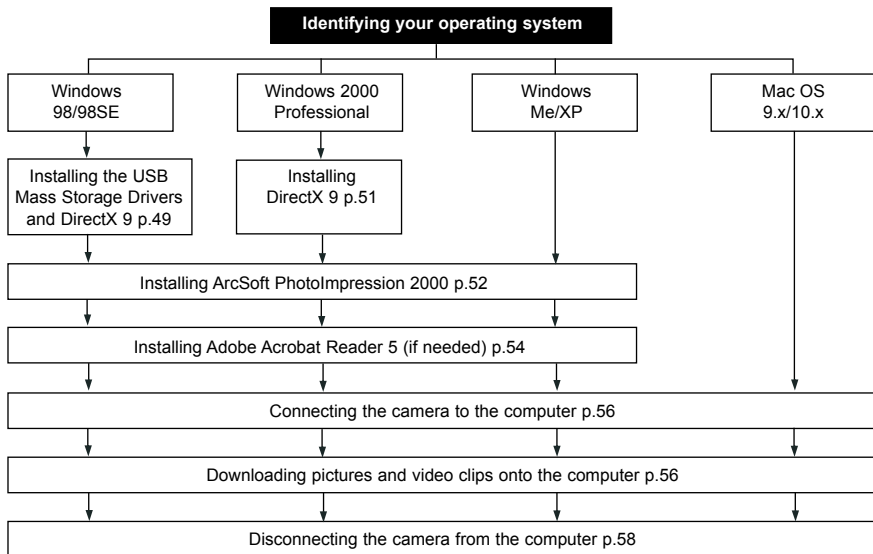

Data transfer may not function correctly if you have one of the operating systems listed below or you are using an add-on USB adapter or USB hub.

- Windows 95
- Windows NT 3.51/4.0
- Mac OS 8.6 or lower.
- Home-built computer systems or computer systems without a factory installed operating system.
- Home-installed operating system or upgrade to the operating system.

IDENTIFYING YOUR OPERATING SYSTEM

Windows

1. Right click the **My Computer** icon on your desktop, and go to Properties.
2. The System Properties Box will appear.(fig.1.1)
The information about your computer is listed under the system area.
3. Confirm that your computer is running one of the following operating systems and proceed to the page in the chart for installation instructions:



System	Proceed to page
Windows 98, Windows 98 Second Edition	Page 49
Windows 2000	Page 51
Windows Millennium Edition, Windows XP Home Edition, Windows XP Professional Edition, Windows XP Media Center Edition	Page 52

4. Press **OK** to close the window

For Windows 98/98SE/Me/2000, if the **My Computer** icon is not on your desktop, click **Start > Settings > Control Panel** to display the Control Panel window (fig. 1.2). Double click on System icon to open the System Properties Box (fig. 1.2).

For Windows XP, if the **My Computer** icon is not on your desktop, click **Start > Control Panel > Performance and Maintenance**, then click on the System icon to open the System Properties Box (fig.1.1).





Macintosh



1. In the Apple Menu on the Menu bar, select **About this Computer**.
2. A window will appear with the computer's operating system version. Confirm that your computer is version 9 or higher.

No installation of software is necessary for Macintosh users, please go to Page 56 for connecting your camera to the computer.



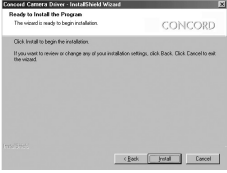
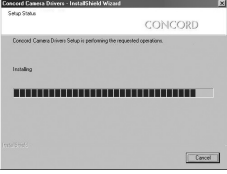

INSTALLING THE DRIVER AND DIRECTX 9 – WINDOWS 98/98SE

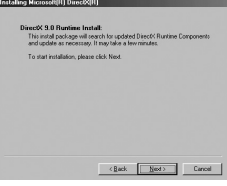
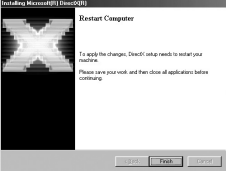
Do not connect the camera to your computer **BEFORE** the camera drivers and Microsoft DirectX 9 installation is completed.



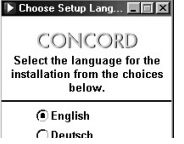

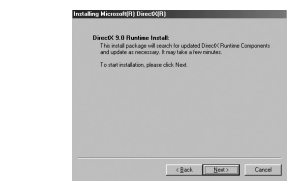
Step 1	Make sure your camera is powered off and not connected to the computer.
Step 2	Make sure the computer is powered on and Windows 98 or 98SE is running.
Step 3	Close any other applications or software you may be running.
Step 4	<p>Insert the supplied CD-ROM into your computer's CD-ROM Drive.</p> <p>NOTE: If the installer does not start automatically within 30 seconds after the CD-ROM has been inserted, click on "My Computer" either on the Desktop or in the Start Menu and locate the CD-ROM Drive. Double click on the CD-ROM Drive icon for installation and proceed to Step 5.</p>
Step 5	<p>Select the language. Click [OK].</p> 
Step 6	<p>The installation screen will appear. Click on Install Camera Drivers.</p> 
Step 7	<p>Click [Next >].</p> 
Step 8	<p>The next dialog will prompt you to select the components that will be installed. USB Mass Storage Driver and DirectX 9 will be pre-selected.</p> <p>The files will be saved in the Concord Camera directory automatically.</p> <p>OR</p> <p>You may change the default folder by clicking [Browse...] and selecting a different folder in your computer.</p> <p>Click [Next >].</p> 

<p>Step 9</p>	<p>Click [Install].</p>	
<p>Step 10</p>	<p>Install progress bar</p>	
<p>Step 11</p>	<p>The next screen will begin the DirectX setup. Select " I accept the agreement " then click [Next >].</p>	
<p>Step 12</p>	<p>Click [Next >].</p>	
<p>Step 13</p>	<p>Click [Finish]. Your computer will automatically restart.</p>	

INSTALLING DIRECTX 9– WINDOWS 2000

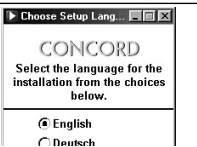

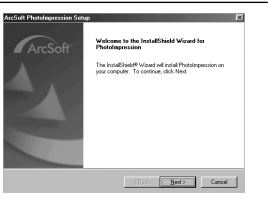

Step 1	Make sure your camera is powered off and not connected to the computer.	
Step 2	Make sure the computer is powered on and Windows 2000 is running.	
Step 3	Close any other applications or software you may be running.	
Step 4	Insert the supplied CD-ROM into your computer's CD-ROM Drive. NOTE: If the installer does not start automatically within 30 seconds after the CD-ROM has been inserted, click on "My Computer" either on the Desktop or in the Start Menu and locate the CD-ROM Drive. Double click on the CD-ROM Drive icon for installation and proceed to Step 5.	
Step 5	Select the language. Click [OK] .	
Step 6	The installation screen will appear, click on Install Microsoft DirectX 9.0 .	
Step 7	The next screen will begin the DirectX setup. Select " I accept the agreement " then click [Next >] .	
Step 8	Click [Next >] .	
Step 9	Click [Finish] . Your computer will automatically restart.	

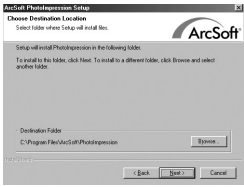
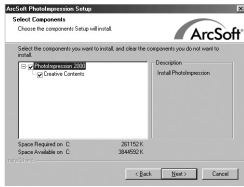
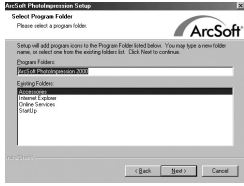
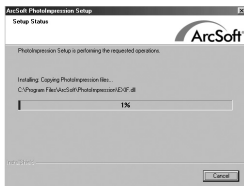
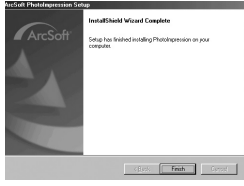

INSTALLING ARCSOFT PHOTOIMPRESSION – ALL WINDOWS USERS

Step 1	Make sure your camera is powered off and not connected to the computer.	
Step 2	Make sure the computer is powered on and Windows is running.	
Step 3	Close any other applications or software you may be running.	
Step 4	<p>Insert the supplied CD-ROM into your computer's CD-ROM Drive.</p> <p>NOTE: If the installer does not start automatically within 30 seconds after the CD-ROM has been inserted, click on "My Computer" either on the Desktop or in the Start Menu and locate the CD-ROM Drive. Double click on the CD-ROM Drive icon for installation and proceed to Step 5.</p>	
Step 5	Select the language. Click [OK].	
Step 6	The installation screen will appear, Click on Install ArcSoft Photolmpression 2000 .	
Step 7	Click [Next >].	
Step 8	Click [Yes].	

<p>EN</p> <p>Step 9</p>	<p>Click [Next >].</p>	
<p>Step 10</p>	<p>Make sure the two applications are checked and then click [Next >].</p>	
<p>Step 11</p>	<p>Click [Next >].</p>	
<p>Step 12</p>	<p>The screen will show the status of the installation.</p>	
<p>Step 13</p>	<p>Click [Finish]. Win98 will request for restart.</p>	

INSTALLING ADOBE ACROBAT READER 5- ALL WINDOWS USERS (OPTIONAL)

Step 1	Make sure your camera is powered off and not connected to the computer.	
Step 2	Make sure the computer is powered on and Windows is running.	
Step 3	Close any other applications or software you may be running.	
Step 4	Insert the supplied CD-ROM into your computer's CD-ROM Drive. NOTE: If the installer does not start automatically within 30 seconds after the CD-ROM has been inserted, click on "My Computer" either on the Desktop or in the Start Menu and locate the CD-ROM Drive. Double click on the CD-ROM Drive icon for installation and proceed to Step 5.	
Step 5	Select the language. Click [OK].	
Step 6	The installation screen will appear, Click on Install Adobe Acrobat Reader 5 .	
Step 7	Status bar	
Step 8	Click [Next >].	

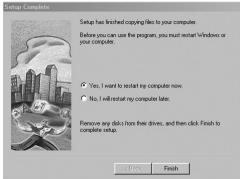
<p>Step 9</p>	<p>The files will be saved into C:\Program Files\Adobe\Acrobat 5 automatically.</p> <p>OR</p> <p>You may change the default folder by clicking [Browse...] and selecting a different folder in your computer.</p> <p>Click [Next >].</p>	
<p>Step 10</p>	<p>Installation progress</p>	
<p>Step 11</p>	<p>Select Yes, to restart the computer or No, to restart the computer later.</p> <p>Click [Finish >].</p>	

CONNECTING THE CAMERA TO THE COMPUTER

Windows 98/98SE users - Do not connect the camera to your computer **BEFORE** the camera drivers and Microsoft DirectX 9 installation is completed.

1. Power the camera on.
2. Connect the camera to the computer with the Mini-USB cable provided.
 - Plug the larger end of the Mini-USB cable that is included with the camera into your PC's USB port. (Please refer to your computer's documentation for more information on the location of the USB port.)
 - Plug the small end of the Mini-USB cable into the USB port located in the Cable Connection panel on the side of the camera.
3. When the camera is connected to the computer for the first time, the camera USB Mass Storage driver installation will begin. Please follow the on-screen instructions to complete the installation.

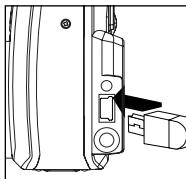

DOWNLOADING PICTURES AND VIDEO CLIPS ONTO YOUR COMPUTER

Note: Windows 98/98SE users must install the Camera Driver and DirectX 9 first. (Page 49)

Note: Windows 2000 users must install DirectX 9 to view video clips on the computer. (Page 51)

Downloading files from the camera:

- Insert the memory card.

Caution: Do not attempt to open the battery/memory door to insert or remove the memory and/or batteries when the camera is connected to the computer.

FOR WINDOWS USERS

Downloading Pictures and Video Clips onto your computer:

1. Connect the camera to the computer.
2. Double-click on My Computer.
3. Double-click Removable Disk.
4. Double-click DCIM.
5. Double-click the folder that contains the desired images to view.
 - The pictures (JPEG) and video clips (AVI) stored in the memory will be displayed.
6. Click and drag the files into a directory in your computer to save them.
 - To select all files, click Edit > Select all.

FOR MACINTOSH USERS

1. Connect the camera to the computer.
 - After a few moments, the external hard drive will appear on the desktop.
2. Double-click the "CONCORD" removable drive that is on your desktop.
3. Double-click DCIM.
4. Double-click the folder that contains the desired images to view.
 - The stored pictures (JPEG) and video clips (AVI) stored in the memory will be displayed.
5. Drag and drop the image you want to save in the computer.
 - To select all files, click Edit > Select all.

Note: You may also transfer the stored pictures and video clips onto your computer by using a memory card reader (sold separately.)

USING ARCSOFT PHOTOIMPRESSION (WINDOWS ONLY)

1. Connect the camera to the computer.
2. Launch ArcSoft Photolmpression software by clicking on Start-Programs-ArcSoft Camera Suite and choosing PhotoImpression from the application list on your screen. (fig. 1.1)



fig. 1.1



fig. 1.2

3. When the Application opens, click on the Camera/Scanner button.(fig. 1.2)
4. Click on the drop-down list under Select Source and choose Concord Camera.
5. Click on the Camera/ Scanner Icon ().
 - A second window will appear showing the contents (pictures) in the memory, and options on how to handle them. (fig. 1.3)

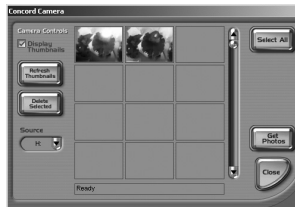

fig. 1.3

6. Select the desired picture to view, edit or save by clicking on it. The selected image will be highlighted by a border. To choose all pictures, click on **Select All**.
7. Click on Get Photos.
The pictures will then be added to the album at the bottom of the application (fig. 1.4).



fig. 1.4



8. Click on **Close** to close the Camera Controls windows (as shown in fig. 1.3).
9. Double-click on the thumbnail or click on **OK** to open the photo.
10. Click on **Edit** to edit the photo. You may, for example,
 - Resize the photo by using the "Crop/Resize" tools.
 - Modify the photo by using the "Retouch" tools. For example, to remove red-eyes.
 - Add some text onto the photo by using the "Text" tools.
11. Click on **Save** to save the photo. Two options are available: "Save" and "Save As".
12. Click on **Print** to print the photo. The options available include: **Standard Printing, Greeting Card/Multiple Printing or Thumbnail Printing.**

UNPLUGGING YOUR CAMERA FROM THE COMPUTER

Windows ME/2000/XP:

1. Click once on the "Unplug or Eject Hardware" icon on the right hand side of your task bar. (fig.1.1)
2. Select "Stop Concord Camera USB Mass Storage Device"
3. Click **[OK]** in the "Safe to Remove Hardware" prompt.
4. Unplug the Mini-USB from the camera. (fig.1.2)



fig.1.1

Macintosh:

1. Drag the "CONCORD" removable drive icon on the desktop to the Trash. Or click on "CONCORD", then click "Eject" under "File" or "Special" (if the mouse is not available).
2. Unplug the Mini-USB cable from the camera.

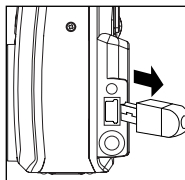
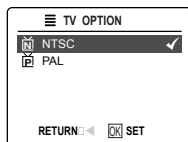
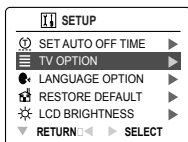



fig.1.2

TV MODE

CHANGING THE TV MODE SETTING

The camera allows you to view individual files and to take pictures or record clips on the television. To begin, check your television documentation to determine the suitable type of TV broadcast standard (TV OPTION): NTSC or PAL.



1. Slide the Mode switch to () Camera Mode
2. Press the **MENU** button.
3. Press **▲** or **▼** repeatedly until Setup is highlighted.
4. Press **▶** to enter the Setup menu.
5. In the Setup menu press **▲** or **▼** until TV option is highlighted
6. Press **▶** to enter the TV submenu.
7. Press **▲** or **▼** to change the setting to NTSC or PAL and press **OK**.
8. Press the **MENU** button to exit.

CONNECTING THE CAMERA TO THE TELEVISION

1. Connect the red sound terminal of the AV cable to the sound terminal marked AUDIO of your TV, and connect the yellow image terminal of the AV cable to the image input terminal jack marked VIDEO or VIDEO IN on your television.
2. Turn on your television.
3. Set the television to video mode according to the instructions in the owner's manual. (This is usually channel 3, 4 or AV).
4. Connect the other end of the cable into the VIDEO port located in the cable connection panel.

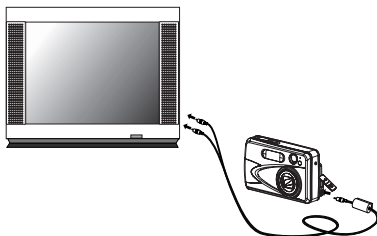

USING THE TV AS A LIVE VIEWFINDER

1. Connect the camera to the TV.
2. Turn the camera on.
3. Slide the Mode Switch to () Camera Mode.
4. The TV will become a Live Viewfinder.



Note: You may record your TV Mode session by using your VCR. Please refer to your VCR documentation to learn more about recording.

REVIEWING PICTURES AND VIDEO CLIPS ON YOUR TV

1. Connect the camera to the TV.
2. Turn the camera on.
3. Slide the Mode Switch to () Review mode.
4. Press **▲** or **▼** to scroll through the saved pictures and video clips.
 - When an AVI file is displayed on the TV, press the **OK** button to view the video clip.
5. To view more options, press the **MENU** button to display the menu on the TV screen. Please refer to page 32/37 for further information.

ERROR MESSAGES

Error Messages appear on the LCD when the memory is full or when there is a problem with the SD card.

Error Message	Cause	Solution
Memory Full	Memory (either internal memory or SD card) is full.	Follow one of the below methods: 1) Delete unwanted files. 2) Insert an SD card or replace the SD card with another that has free memory space. 3) Transfer the photos/video clips onto your computer.
Memory Full 	The SD card memory isn't enough to hold the files saved in the internal memory. Only part of the files in the internal memory is transferred.	Follow one of the below methods: 1) Delete unwanted files. 2) Insert an SD card, or replace the SD card with a new one. 3) Transfer the photos/video clips onto your computer.
Memory Error	The camera's internal memory may be corrupted.	Format the internal memory (P.41) first. If the problem remains after formatting, that means the internal memory is corrupted. You can either use an SD card as storage or send the camera for repairing.
Card Error	The SD card may be corrupted.	Format the SD card first. If the problem still exists after formatting, replace the corrupted SD card with a new one.
Incompatible Media Formatting will erase All data Continue?	The memory card is not recognizable (maybe the card is new or used on other digital cameras).	Format the SD card.
	The memory card is locked.	Turn off the camera, take out the SD card and unlock the SD card.
No Card	Attempts to transfer files when an SD card is not inserted into the camera.	Insert an SD card with enough free memory.
Format Error	The internal memory or the SD card is corrupted.	For an internal memory problem, use an SD card as storage instead. For an SD card problem, replace the SD card with a new one.

TROUBLESHOOTING

SYMPTOM	POSSIBLE CAUSE	POSSIBLE SOLUTION
CAMERA		
Cannot turn on the camera.	Batteries are not installed correctly.	Install batteries correctly by following the indication engraved on the edge of the battery compartment or that on the battery contact.
	Batteries are flat or weak.	Replace batteries.
	Battery door is not closed properly.	Close the battery compartment door properly.
	To prevent accidentally powering on the camera, it is designed to power on with a set delay.	Press and hold the power button for more than 1 second to power on the camera.
	In cold weather, battery power level might temporarily fall, thereby affecting camera performance.	Try different ways to warm the batteries, for instance: place them in your pocket or warm them with your hands, before re-trying operation.
The camera buttons do not work.	The camera needs to be reset.	Press the reset button on the back of the camera with a pointed object, such as a pen, then power the camera off then on.
The camera turns off during usage.	The batteries are drained of power.	Replace the batteries with new ones.
	Camera automatically powers off and retracts the lens after 2 minutes (default setting) of inactivity.	Press any button to power the camera on again. In the Setup menu, set the Auto-OFF Time to 3 minutes (for detail instructions, see page 39).
The camera cannot turn off the Auto-Focus setting.		The Concord Camera is designed to have the Auto-Focus setting.
LCD displays white screen when powered on.	This can occur when the camera is repeatedly powered on/off in quick successions.	Wait for a few seconds between powering on or off the camera.
PICTURES/VIDEO CLIPS		
Picture/Vide clip has poor image quality.	Poor Lighting.	Increase the lighting in the surrounding area when taking pictures and video clips.
	Lens is dirty.	Clean the lens with a soft cloth. Refer to the Safety Tips and Maintenance section (p. 71).
	Subject is too close.	Stand at least 2 ft. (0.6m) away from the subject in the Normal Mode. In Macro Mode, keep the camera and the subject within the range of 5.9 inch (15cm) to 2ft (60cm).

SYMPTOM	POSSIBLE CAUSE	POSSIBLE SOLUTION
The images are dark on the computer and when printing, but all images look fine in Review Mode.	Configuration and settings of computer and printer need to be adjusted.	The display setting of the computer can be adjusted via the Control Panel's Display section or the actual display settings of the monitor. The printer's setting can be adjusted via the Control Panel's Printers. Refer to the user's documentation that comes with the computer and printer.
TAKING PICTURES		
Flash picture taken is too light.	Subject is too close.	Move the subject further away from the camera.
	The flash is not needed.	Change the camera setting to Auto Flash. See p. 12.
	Lighting condition is too bright.	Decrease exposure compensation. See p.22.
Flash Picture taken is too dark.	The subject is too far away for the flash to be effective.	Move the subject closer to the camera, or move the camera closer to the subject.
	Flash is not on.	Select "Auto Flash" or "Flash On" setting.
	The subject is in front of a bright light.	Change the subject's position if possible or move to another location to take the picture of the subject from another angle.
	Lighting condition is too dark.	Increase the exposure compensation. See p. 22.
Flash did not work.	There was sufficient lighting for the picture, so the flash did not fire. This happens when the camera is set to Auto Flash.	This is normal, as your camera's electronic light sensor is programmed to only fire the flash when needed.
	Camera's flash has been turned off.	Select "Auto Flash" or "Flash On" setting.
	Flash did not charge.	Ensure that the Ready LED has stopped blinking before taking a picture.
	Selected the Continuous or Sport mode.	When the Continuous or Sport mode is selected, the flash is disabled.
My fresh set of batteries took only a few pictures and they are now flat.	Depends on the level of usage. Auto-Focusing, zooming in and out are some of the functions that tend to draw more power.	To save power, turn off the LCD. When the camera is not in use, power it off. Economize on the use of the Auto-Focus and zooming functions

SYMPTOM	POSSIBLE CAUSE	POSSIBLE SOLUTION
My fresh set of batteries took only a few pictures and they are now flat.	Are the fresh batteries newly purchased?	So-called fresh batteries that have been purchased a long time ago cannot be considered fresh; as battery power tends to drop over an extended period of time.
	Are the battery contacts dirty?	Every once in a while battery contacts need to be cleaned. Refer to the Safety Tips and Maintenance section (p. 71).
Picture taken is blurry.	Subject or camera moved as the picture was taken.	<ol style="list-style-type: none"> 1. Hold camera steady until the picture is taken. 2. Select the Sport capture mode for fast-action-oriented subjects.
	The focus was not locked before taking the picture.	Before taking a picture, press the Shutter Button halfway to lock the focus (the green LED besides the optical viewfinder will remain ON and the Focus Mark at the center of display will be green), then press the Shutter Button fully to capture the picture. (p.11)
	Check that the Marco mode is not selected.	Use the Marco mode only for shooting distances between 2.9ft (15cm) ~ 2ft (60cm). Otherwise, use the normal capture mode.
	The lens is dirty.	Clean the lens with professional lens cleansing paper or use a piece of lint-free, soft-dust-free cloth to gently wipe the lens.
	The subject is not located at the center of the focus mark when composing the image.	Make sure the subject is centered in the focus mark when composing the image.
	There is something wrong with the color of the	White balance is not set properly.
photographs.	The white balance is not correctly adjusted.	Aim the camera at something white such as a white piece of paper, press the Shutter button half-way to adjust the white balance to the subject's lighting condition.
Cannot take a picture or record a video clip.	Memory is full.	Insert a memory card with sufficient memory available.
		Download the stored files to your PC and delete the files from the memory card.
		Delete unwanted pictures and continue shooting.

SYMPTOM	POSSIBLE CAUSE	POSSIBLE SOLUTION
	Camera is not set in picture/video clip taking mode.	Set the camera to the proper mode for recording video clips, or taking photographs.
	Power is off.	Turn the power on.
	Camera is in Auto Power off Mode.	Turn the power on.
	The remaining battery power is low.	Replace the batteries.
	Camera is connected to a computer.	Disconnect the camera from the computer before taking pictures.
Cannot take a picture or record a video clip when using an SD memory card.	The SD card is locked or write-protected.	Remove the SD card from the card slot and slide the lock switch to off.
	The SD card cannot be recognized.	Format the inserted SD card before using it to take pictures.
Picture is blurred when looking through the viewfinder.	Viewfinder is dirty.	Clean the Viewfinder with a soft cloth or cotton swab. See the Camera maintenance section.
Part of the picture/ video clip is missing.	Something was blocking the lens when taking the picture.	Keep hands, fingers, etc. away from the lens when taking a picture.
	The picture was not centered correctly in the viewfinder.	Leave space around the subject when centering the picture in the viewfinder.
Camera is not responding during picture capture.	The battery level is low and the camera does not have sufficient power to complete picture capture.	Replace batteries
	The camera needs to be reset.	Press the reset button at the back of the camera with a pointed object, such as a pen, then power the camera off then on.
The Shutter button does not work.	The camera is not turned on.	Turn the camera on.
	The camera is processing a picture; the ready LED light is still blinking.	Wait until the light stops blinking before attempting to take another picture.
Picture taken did not save in memory.	The camera powered off before completing the save operation.	If the low-battery indicator appears on display, replace batteries with a fresh set.
	The memory card was removed before completing the save operation.	DO NOT open the battery/memory card compartment door when the camera is powered on, as it could corrupt the memory card.
	Battery door was opened before completing the save operation.	Ensure that the battery/memory card compartment door is properly and securely closed before taking pictures.

SYMPTOM	POSSIBLE CAUSE	POSSIBLE SOLUTION
LCD		
The LCD display is dark.	Protective plastic film is still in place on the camera.	Make sure the protective plastic film covering the LCD (for protection purposes during shipment) has been removed.
	The LCD brightness level is set too low or the surrounding lighting condition is poor.	Increase the brightness level on your LCD to meet your personal needs. See p.40 for setting the brightness.
The LCD is dim or visibility is poor.	The set LCD brightness level is too low.	Adjust the brightness in the Setup mode, see page 40.
	When using the camera in sunny conditions, the visibility of the LCD may seem dim.	Shade the display for better visibility. .
The LCD screen looks milky and or scratched.	Protective plastic film is still in place on the camera.	Make sure the protective plastic film covering the LCD (for protection purposes during shipment) has been removed.
The LCD is not displaying anything.	LCD is turned off.	Turn the LCD on, by pressing ().
	The battery level is low.	Replace the batteries.
LCD does not display stored images.	The camera is in the picture capturing mode.	Set the camera to review mode.
	The camera is connected to a television.	The LCD turns off when the camera is connected to a television.
VIEWING VIDEO CLIPS ON THE COMPUTER (WINDOWS 98/98SE/2000)		
Cannot playback stored video clips on the computer.	Video playback files are missing.	Install Microsoft DirectX 9. (p.49)
INSTALLING SOFTWARE AND DRIVERS		
Camera is not responding during picture download to the computer.	The operating system may not be allocating adequate resources to download the pictures.	Reset the camera by pressing the reset button with a pointed object such as a pen. Reboot the computer.
	The Mini-USB cable is not plugged into the camera.	Check that the Mini-USB cable is plugged into the camera.
	The Mini-USB cable is not plugged into the computer.	Check that the USB cable is plugged into the computer.

SYMPTOM	POSSIBLE CAUSE	POSSIBLE SOLUTION
Camera is not responding during picture download to the computer.	The USB port of computer is damaged.	Replace or repair the USB port.
	The USB cable is damaged.	Replace the USB cable.
	Computer cannot detect the newly installed driver	Update the driver in My Computer > Properties > Hardware > Device Manager.
	The driver did not install successfully.	Uninstall and re-install the driver.
	The computer is not powered on.	Turn your computer on.
Cannot transfer pictures to the computer. The New Hardware Wizard cannot locate drivers. (Windows 98/98SE)	The Software is not installed on the computer.	Disconnect the Mini-USB cable from the camera and the computer. Install the camera software and drivers. (p.49)
	Software is not fully or correctly installed on the computer.	Disconnect the Mini-USB cable from the camera and the computer. Uninstall the software: click Start >Setting > Control Panel > Add/ Remove Programs. Re-install the camera drivers. (See p.49)
SD CARDS		
The camera does not recognize your SD Card.	The card may not be SD certified.	Purchase a certified SD card.
	The card may be corrupted. Reformat the card.	Caution: Formatting erases all data on the card. P.41
	No card is inserted in the camera.	Insert a card into the card slot. See p.8
	The card is locked.	Take out the card and unlock.
RECHARGEABLE BATTERIES		
A low battery warning appears during initial use of the freshly charged batteries.	The batteries might not have been charged properly.	Recharge the batteries to maximum capacity (confirm the needed duration of re-charge time)
	The batteries haven't reached their maximum capacity.	Fully charge/discharge the batteries via normal operation for three to four cycles
Camera is not responding during picture download to the computer.	The battery contact is dirty.	Clean the battery contacts and battery polarities with alcohol and a soft, dust-free, lint-free, clean cloth.
	Excessive zooming and powering on/off operations	Avoid these kinds of unnecessary operations.

GETTING HELP

Troubleshooting Section in this User's Guide

Please refer to the Troubleshooting section (page 61) first, as it contains some of the most common problems that users encounter. The section lists a number of possible quick-and-easy solutions, which might solve the problem, allowing you to continue enjoying your new Concord 3-Megapixel 3x Optical Zoom Digital Camera

.Website Customer Support/FAQ

For problems that are not listed in the Troubleshooting section, please visit our customer support website at www.concord-camera.com to view the Frequently Asked Questions (FAQ) by clicking the appropriate camera model picture in the "Camera Support" Section. Most of the latest support issues are posted and answered in the FAQ section. If the problem you are encountering is not listed either in the troubleshooting section of this User's Guide or the FAQ section on our website, you can also E-mail us by clicking the E-mail address link to the customer support center in the "Camera Support" Section.

Customer Support Before You E-mail or Call us

If you have questions concerning the operation of the camera or software installation that are not listed either in the troubleshooting section of this User's Guide or the FAQ section on our website, feel free to speak to or email a customer service representative. Before emailing or calling us, please have the following information ready:

Camera Information:

Name of camera model
Camera Serial Number

Computer Information:

Operating System
Processor Speed (MHz)
Computer Maker and Model
Amount of memory
Exact Error message received

For ArcSoft Technical Support on Photo Editing Software, please contact:

In the USA and Canada

ArcSoft, Inc.
46601 Fremont Blvd.
Fremont, CA 94538
Tel: (510) 440-9901
Fax: (510) 440-1270
E-mail: support@arcsoft.com

China

ArcSoft Beijing Co., Ltd.
No. 6 South Capital Gym Road
Beijing New Century Hotel Office
Building, #1060
Beijing 100044, China
Tel: 8610-6849-1368
Fax: 8610-6849-1367
E-Mail: tech@arcsoft.com.cn

Japan

ArcSoft Japan
9F, 1-21-9, Higashi-Gotanda,
Shinagawa-ku,
Tokyo 141-0022, Japan
Tel: +81-3-5795-1392
Fax: +81-3-5795-1397
E-Mail: support@arcsoft.jp

Europe

Unit 14, Shannon Industrial Estate
Shannon, Co. Clare, Ireland
Tel: +353 (0) 61-702087
Fax: +353 (0) 61-702001
E-Mail: europe@arcsoft.com

Latin America (local call only)

Tel (Brazil): 00817-200-0709
Tel (Chile): 800-202-797
E-Mail:
latinsupport@arcsoftsupport.com

Taiwan

ArcSoft Inc. Taiwan Branch
Tel: +886 (0) 2-2506-9355
Fax: +886 (0) 2-2506-8922
E-Mail: support@arcsoft.com.tw

CAMERA SPECIFICATIONS

Lens	7.25 - 21.7mm (equivalent to 38-114 mm in 35mm format), f/2.8 - f/4.7, 6 groups 6 elements all glass.
Aperture	2 steps: f/2.8 and f/5.6 at wide zoom position
Shutter	Electronic, 4s – 1/1000s
Optical Zoom	3x in 6 steps
Digital Zoom	4x
Focus Range	Auto Focus from 60cm to infinity (23.6 in. to infinity), macro from 15 cm to 60 cm (5.9 in. to 23.6 in.)
Focusing System	5 area Multi-area AF, Center Spot AF
Image Sensor Type	1/1.2" CMOS
Sensor Effective Pixels	3.1 Megapixels
Image Aspect Ratio	4:3
Image Size	2048 x 1536, 1600 x 1200, 1024 x 768, 640 x 480
Image Quality	Fine (4.5:1), Normal (11:1), Economy (17:1)
Sensitivity (ISO setting)	Auto, 100, 200, 400 (user selectable)
Capture Mode	Single Shot, Sport, Continuous Shot, Sport + Continuous Shot
Exposure	Auto
Auto Exposure metering	Spot, Matrix
White Balance	Auto, Sunny, Fluorescent, Tungsten
Scene Selection	Off, Party/Indoor, Beach, Snow, Night Landscape, Sunset, Fireworks, Night portrait.
Picture Effect	Off, B&W, Sepia
Exposure Compensation	+/-0, 0.3, 0.7, 1.0, 1.3, 1.7, 2.0 EV
Continuous Shoot	7 frames in 2.3sec with 640x480 resolution
Video Clips	AVI format, • 320x240 or 160x120 resolution with 20 fps, approx 25sec with 6MB storage.
Self-Timer	10s delay with blinking red LED (7s slow blinking and 3s fast blinking), available for camera and video clip.
Storage Type	Internal Memory and SD card
Internal Storage	6MB Internal Non-Volatile Memory

Storage Capacity

Images Stored on 6MB memory (approx.):

Image Quality	Image Size			
	3MP (2048 x 1536)	2MP (1600 x 1200)	1.3MP (1024 x 768)	VGA (640 x 480)
Fine (4.5:1)	4	6	14	36
Normal (11:1)	8	13	32	79
Economy (17:1)	15	23	55	130

Images Stored on 16MB memory (approx.):

Image Quality	Image Size			
	3MP (2048 x 1536)	2MP (1600 x 1200)	1.3MP (1024 x 768)	VGA (640 x 480)
Fine (4.5:1)	9	14	33	82
Normal (11:1)	19	31	74	181
Economy (17:1)	34	53	125	297

Images Stored on 32MB memory (approx.):

Image Quality	Image Size			
	3MP (2048 x 1536)	2MP (1600 x 1200)	1.3MP (1024 x 768)	VGA (640 x 480)
Fine (4.5:1)	20	29	68	171
Normal	41	65	154	376
Economy	71	111	261	616

Images Stored on 64MB memory (approx.):

Image Quality	Image Size			
	3MP (2048 x 1536)	2MP (1600 x 1200)	1.3MP (1024 x 768)	VGA (640 x 480)
Fine (4.5:1)	42	60	140	351
Normal	84	135	316	771
Economy	146	229	536	1270

Images Stored on 128MB memory (approx.):

Image Quality	Image Size			
	3MP (2048 x 1536)	2MP (1600 x 1200)	1.3MP (1024 x 768)	VGA (640 x 480)
Fine (4.5:1)	83	119	279	698
Normal	167	268	628	1532
Economy	290	455	1064	2512

Output file format

JPEG compression with EXIF 2.2

Optical Viewfinder

Real image zoom finder with 70-90% coverage

LCD

1.5" TFT LCD, 280(H) x 220(V), 61,600 Pixels

Playback Zoom	2x, 4x (for 2048 x 1536, 1600x1200, 1280x960); 2x (for 640x480)
Flash Mode	Auto, Auto + RER, Flash ON and Flash off.
Flash Range	0.6 to 2.6m (1.97 to 8.53ft) in Wide; 0.6 to 1.7m(1.97 to 5.58ft) in Tele@ISO100 0.6 to 3.5m (1.97 to 11.48ft) in Wide; 0.6 to 2.1m(1.97 to 6.89ft) in Tele@ISO200
User Interface	All information and menus are displayed on TFT LCD display, Review Image, shows frame counter, flash status, self timer, focus mode, image quality, image size, battery status and memory card.
Multi Language Support	User selectable UI on TFT OSD menu. The languages included are Spanish, Italian, German, English, French, Dutch, Simplified Chinese, Japanese and Portuguese.
Mode Selection	Slide Switch for Camera, Review, Video
Slide Show	Yes
AF Assist Light	Yes
Speaker	Yes
Tripod Socket	Standard 1/4" size
Connectivity	Mini USB and TV/VCR Out
System Connectivity	Mass Storage Driver for Window 98, 98SE,2000,ME, XP Mass Storage Driver for Mac OS 9.x and Mac OS OS X
Time Out	1 minute for LCD. 2 minutes or 3 minutes programmable auto power off for camera.
Power Source	2x AA batteries, can use alkaline, lithium and rechargeable NiMH type (Rechargeable NiMH type Highly Recommended)
Dimensions	100 x 61 x 31.5 mm without protrusions
Weight	160g without batteries and memory card
Accessories	See the separate "Packing Content" sheet.

SAFETY TIPS AND MAINTENANCE

Cleaning the camera body:

1. Please use a soft, dry and dust-free cloth to clean the camera.

Cleaning the lens, viewfinder and LCD:

1. Blow off dirt or dust with a blower or canned air.
2. Gently wipe the lens, viewfinder and/or LCD with a micro-fiber cloth.
3. To remove dirt or residue, moisten the cloth with lens cleaning fluid and gently wipe the lens, viewfinder and/or LCD.

CAUTION: Do not apply the fluid directly onto the lens, viewfinder or LCD.

Cleaning the battery contacts:

As a matter of routine operation and handling, should any debris or foreign contaminant deposit itself on the battery contacts in the camera and/or on the batteries, follow steps below to clean the battery contacts to ensure proper electrical operation:

1. Wet the tip of a cotton bud/swab with rubbing alcohol and squeeze (with clean fingers) the excess alcohol from the bud/swab.
2. Wipe the battery contacts inside the camera battery compartment and both ends of the batteries lightly with the damp bud.
3. Allow the contacts to dry before placing batteries in the camera.

Caution:

- 1) Do not press hard during cleaning, as this will damage the battery contacts.
- 2) Do not use water to clean the contacts, as this will increase the chance of oxidation.
- 3) Do not use Acetone or Nail Polish remover to clean the contacts as this may adversely affect camera operation.

SAFETY TIPS

Precautions for the camera:

- Do not attempt to modify this camera in any way. This may cause a fire, electric shock or severe damage to the camera.
- Do not use the flash in close proximity to people or animals.
- When taking photographs, never point the lens of the camera directly into very strong light.
- Please do not use this product in close proximity to flammable or explosive gases as this could increase the risk of explosion.
- For safety reasons keep this product and accessories out of reach of children or animals to prevent accidents.
- Do not swallow batteries or small camera accessories.
- Keep the camera away from water and other liquids, and never let it get wet. Do not use the camera outdoors outdoors amid rain, snow or hail.
- Should any form of liquid enter the camera, do not use it. Switch the camera off, and then remove the batteries. Do not continue to use the camera as this may cause a fire or electric shock.
- Do not insert or drop metallic or inflammable foreign objects into the camera through access points e.g. card slot and battery chamber. This may cause a fire or electric shock.
- Do not operate this camera with wet hands. This could pose a risk of electric shock.
- Under the environment with electrostatic discharge, the camera may malfunction and require the user to reset the camera.
- Under the environment with electrical fast transients (EFT), the camera may lose function and require user to reset the camera.
- Shielded cables must be used with this unit to ensure compliance with the Class B FCC limits.
- Please avoid using the camera in high or low temperature. Operation temperature range 32°F - 104°F (0°C - 40°C).
- It is normal that the temperature of the camera body rises after being in use for a long period.
- Do not leave this camera in places subject to extremely high temperatures, such as in a sealed vehicle, under direct sunlight, or in other places with extreme variances in temperature. Exposure to extreme temperatures may adversely affect the camera's internal components and could cause a fire.
- Always use the camera and its accessories in a well-ventilated area.
- Allowing dust to accumulate in the camera over a long period of time is hazardous and in extreme circumstances may cause a fire. It is best to clean your camera prior to seasonal periods of high humidity.

Precautions for batteries:

- Use 2x AA batteries only.
- Dispose of the batteries in a manner that complies with applicable laws.
- Leakage, overheating, or burst batteries could result in fire or injury.
- Do not short circuit, heat or dispose of batteries in fire.
- Do not use old batteries with new ones, or mix brands of batteries.
- Ensure the batteries are positioned correctly with regard to polarity (+/-).
- Batteries may lose power if kept inside the camera for a long time without using. Please remove the batteries while the camera is not in use.
- Do not use manganese batteries as they cannot supply sufficient power to support the camera's operations. Batteries may not work normally under 32°F (0°C).

Precautions for SD Memory Cards:

- In the event of malfunction or damage, it is possible that data may be lost. Concord Camera is not responsible in any way for such data loss.
- Do not touch the terminals with hands or metal objects.
- Keep dust, liquid and direct sunlight when in used or when placed in storage
- Avoid heat, liquid and direct sunlight when using and when storing.
- Do not open the battery/card cover or remove the SD Memory Card while data is being read or written.
- Do not dismantle or modify.
- The recorded data may be lost if the card is affected by strong static electricity, electrical shock, during card

repair or malfunction.

- When using SD Memory Cards do not change the attributes (read-only, etc.) of the files (pictures (JPEG) or video clips (AVI) on the card. Doing so may prevent the camera from working properly when deleting, etc.
- Do not change the file names or the directory name of the pictures or video clips using a computer or save files other than pictures or video clips taken by this camera onto the SD memory card. Pictures or video clips that have been edited or added to the SD memory card with the computer may not play back and it may cause the camera to malfunction.
- The SD Memory Card includes a write-protect switch. Sliding this switch downward prevents data from being written to the card and pictures and video clips saved on the card are protected.
- Please note that pictures and video clips cannot be taken or deleted when the write-protect switch is on.
- When using a large-capacity card, writing, reading and deleting may take some time.
- Do not store the card in places with high humidity, dusty places or where static electricity or electromagnetic fields are likely to occur.
Images stored in the memory card may be ruined or damaged if you turn off the camera while it is in process of reading, writing or formatting etc.
- SD cards are delicate electronic devices. Please do not bend or drop them
- Please do not place the SD card in or near to an environment of strong electronic or magnetic fields such as loud speakers or TV receivers.
- Please keep the SD card in its bag or case when not in use.
- It's normal for the SD card to be warm after use.
- Please make sure you switch off the camera before you remove the SD card.
- Do not open the battery/memory card door or remove the SD Memory Card while the camera is reading, writing or formatting the card.

REGULATOR INFORMATION

FCC INFORMATION

FCC WARNING: This equipment meets the limits for a Class B digital device, pursuant to Part 15 of FCC rules. Only the cable supplied with the camera should be used. Operation with other cables is likely to result in interference to radio and TV reception and could void the user's authorization to operate this equipment. This device complies with Part 15 of the FCC Rules. Operation is subject to the following two conditions:

- This device may not cause harmful interference.
- This device must accept any interference received, including interference that may cause undesired operation.

**Tested to comply
with FCC standards
for HOME OR OFFICE USE**

Changes or modifications not expressly approved by the manufacturer may void the user's authority to operate this equipment.

USER INFORMATION

NOTE: This equipment has been tested and found to comply with the limits for a class B digital device, pursuant to Part 15 of the FCC Rules. These limits are designed to provide reasonable protection against harmful interference in a residential installation. This equipment generates, uses and can radiate radio frequency energy and, if not installed and used in accordance with the instructions, may cause harmful interference to radio communications. However, there is no guarantee that interference will not occur in a particular installation.

If this equipment does cause harmful interference to radio or television reception, which can be determined by turning the equipment on and off, the user is encouraged to try to correct the interference by one or more of the following measures:

- Reorient or relocate the receiving antenna.
- Increase the separation between the equipment and receiver.
- Connect the equipment into an outlet on a circuit different from that to which the receiver is connected.
- Consult the dealer or an experienced radio/TV technician for help.



VCCI INFORMATION

This is a Class B product, to be used in a domestic environment, based on the Technical Requirement of the Voluntary Control Council for Interference (VCCI) from Information Technology Equipment. If this is used near a radio or television receiver in a domestic environment, it may cause radio interference. Please install and use the equipment according to this instruction manual.

 - This product is in conformity with Directive 89/336/EEC.

Concord logo are registered trademarks or trademarks of Concord Camera Corp., in the United States and/or other countries. Microsoft and Windows are either registered trademarks or trademarks of Microsoft Corporation in the United States and/or other countries. Mac and Macintosh are registered trademarks or trademarks of Apple Computer, Inc. in the U.S. and other countries. All other brands and product names are either registered trademarks or trademarks of their respective owners.

This product contains the software product of FUJIFILM "Exif Toolkit For Windows Ver.2.5 (Copyright (C) 1998-2004 FUJI PHOTO FILM CO.,LTD.). Exif is the image file format standard for digital still cameras stipulated by JEITA (Japan Electronics and Information Technology Industries Association).

Visit Concord on the Internet
www.concord-camera.com

Concord 3 Megapixel Digital Camera User's Guide
Copyright 2005 Concord Camera Corp.

Version 1.1
515652-01
R2